

InsightFacility

Owner's Guide

990-91411

November 2020

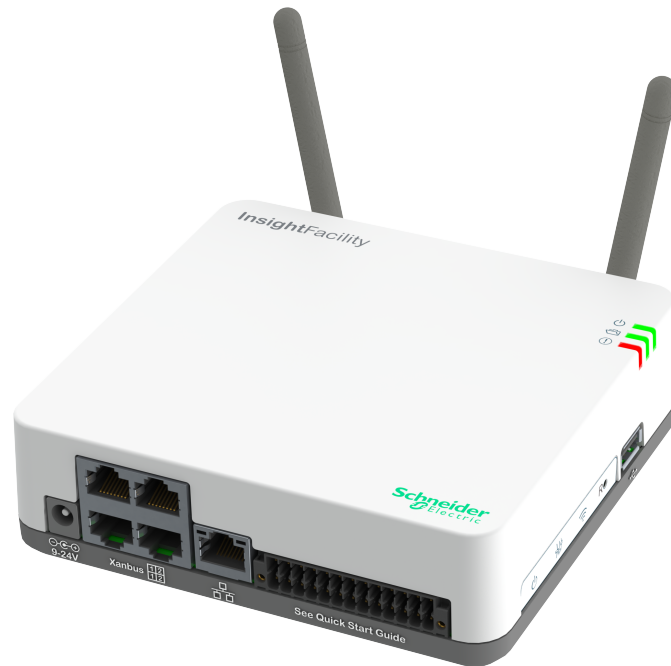

Copyright © 2020 Schneider Electric. All rights reserved.

© 1982-2013, QNX Software Systems Limited. All rights reserved.

Microsoft, Windows, and Internet Explorer are owned by Microsoft. Chrome is owned by Google. Safari and Mac OS are trademarks of Apple Inc., registered in the U.S. and other countries. All other trademarks are owned by Schneider Electric Industries SAS or its affiliated companies.

Exclusion for Documentation

UNLESS SPECIFICALLY AGREED TO IN WRITING, SELLER

(A) MAKES NO WARRANTY AS TO THE ACCURACY, SUFFICIENCY OR SUITABILITY OF ANY TECHNICAL OR OTHER INFORMATION PROVIDED IN ITS MANUALS OR OTHER DOCUMENTATION;

(B) ASSUMES NO RESPONSIBILITY OR LIABILITY FOR LOSSES, DAMAGES, COSTS OR EXPENSES, WHETHER SPECIAL, DIRECT, INDIRECT, CONSEQUENTIAL OR INCIDENTAL, WHICH MIGHT ARISE OUT OF THE USE OF SUCH INFORMATION. THE USE OF ANY SUCH INFORMATION WILL BE ENTIRELY AT THE USER'S RISK; AND

(C) REMINDS YOU THAT IF THIS MANUAL IS IN ANY LANGUAGE OTHER THAN ENGLISH, ALTHOUGH STEPS HAVE BEEN TAKEN TO MAINTAIN THE ACCURACY OF THE TRANSLATION, THE ACCURACY CANNOT BE GUARANTEED. APPROVED CONTENT IS CONTAINED WITH THE ENGLISH LANGUAGE VERSION WHICH IS POSTED AT <http://solar.schneider-electric.com/>.

Document Number: 990-91411

Date: November 2020

Part Number: 865-0335

Contact Information

For country-specific details, please contact your local Schneider Electric Sales Representative or visit the Schneider Electric Solar Business website at: <http://solar.schneider-electric.com/>

Information About Your System

As soon as you open your product, record the following information and be sure to keep your proof of purchase.

Serial Number _____

Product Number _____

Purchased From _____

Purchase Date _____

Safety Information

Important Information

Read these instructions carefully and look at the equipment to become familiar with the device before trying to install, operate, service or maintain it. The following special messages may appear throughout this documentation or on the equipment to warn of potential hazards or to call attention to information that clarifies or simplifies a procedure.

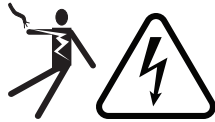

The addition of either symbol to a “Danger” or “Warning” safety label indicates that an electrical hazard exists which will result in personal injury if the instructions are not followed.



This is the safety alert symbol. It is used to alert you to potential personal injury hazards. Obey all safety messages that follow this symbol to avoid possible injury or death.

DANGER

DANGER indicates a hazardous situation which, if not avoided, **will result in** death or serious injury.

WARNING

WARNING indicates a hazardous situation which, if not avoided, **could result in** death or serious injury.

CAUTION

CAUTION indicates a hazardous situation which, if not avoided, **could result in** minor or moderate injury.

NOTICE

NOTICE is used to address practices not related to physical injury.

Please Note

Electrical equipment should be installed, operated, serviced, and maintained only by qualified personnel. No responsibility is assumed by Schneider Electric for any consequences arising out of the use of this material.

A qualified person is one who has skills and knowledge related to the construction, installation, and operation of electrical equipment and has received safety training to recognize and avoid the hazards involved. For more information, see *Audience*.

Product Safety Information

DANGER

HAZARD OF ELECTRIC SHOCK, EXPLOSION, ARC FLASH, AND FIRE

- Read all instructions, cautionary markings, and all other appropriate sections of this guide before installing, operating, troubleshooting or performing maintenance on the InsightFacility.
- Exercise extreme caution at all times to prevent accidents.
- These instructions are for use by qualified installers only.

Failure to follow these instructions will result in death or serious injury.

DANGER

HAZARD OF ELECTRIC SHOCK AND FIRE

- Connect only to Safety Extra Low Voltage (SELV) circuits and limited power sources.
- All wiring must be done by qualified personnel to ensure compliance with all applicable installation codes and regulations.
- For Indoor Use Only.
- Do not disassemble. No user serviceable parts inside.

Failure to follow these instructions will result in death or serious injury.

NOTICE

EQUIPMENT DAMAGE

- All cables connected to the InsightFacility must run indoors and not be susceptible to lightning strikes.
- Turn OFF all devices before connecting cables. The InsightFacility does not have an ON/OFF switch.
- Do not connect an Ethernet cable from the InsightFacility to the WAN/MODEM port on the network router.
- Do not connect an Ethernet cable plug into a Xanbus port on the InsightFacility.
- Do not connect a Xanbus RJ-45 cable plug into the 10/100 Ethernet port of the InsightFacility.
- Do not connect any port on the InsightFacility to an outside line or to a public telecommunication network.
- Ensure that the device connected on the Xanbus network is in standby mode before changing settings. Do not change any settings unless you are familiar with the device.
- Changes to any TCP/IP-related settings should only be performed by a qualified IT professional.

Failure to follow these instructions can result in equipment damage or affect network performance.

NOTICE

EQUIPMENT DAMAGE

- Do not disassemble the InsightFacility.
- See Warranty for instructions on obtaining service.
- The InsightFacility contains no user serviceable parts. Attempting to service the InsightFacility yourself will void your warranty.

Failure to follow these instructions can result in equipment damage.

NOTICE

EQUIPMENT DAMAGE

- Do not port-forward any InsightFacility network ports via a router to the public internet. There is a security risk in port-forwarding unencrypted network traffic over a public network (Internet).
- Use a VPN or a secure tunnel to route InsightFacility communication via the Internet.

Failure to follow these instructions can result in equipment damage.

Audience

This guide is intended for use by anyone who plans to install and operate the InsightFacility communications device as part of their power plant system.

Installation instructions are meant for installers only. The installers have training, knowledge, and experience in:

- Installing electrical equipment.
- Applying all applicable installation codes.
- Analyzing and reducing the hazards involved in performing electrical work.
- Selecting and using Personal Protective Equipment (PPE).
- Changing any TCP/IP-related settings.

Configuration, servicing, and maintenance must be performed by authorized service personnel only. Authorized service personnel meet the requirements for an installer, plus they have received specific training from the manufacturer on servicing the InsightFacility.

About

Purpose

The purpose of this Owner's Guide is to provide explanations and procedures for installing, operating, configuring, maintaining, and troubleshooting the InsightFacility.

Scope

The Owner's Guide provides safety guidelines, planning, and setup information, procedures for installing the product, as well as information about troubleshooting the product. It does not include information on how to install, configure and use other Schneider Electric products.

Firmware Revision

Some InsightFacility features and functions described in this Owner's Guide may be incorporated with later firmware versions. This Owner's Guide is valid for InsightFacility Version 1.05 (always check the website for the latest firmware and user manual). To view the firmware version on your product, see the InsightFacility Status Information in the web user interface.

Abbreviations and Acronyms

DHCP	Dynamic host configuration protocol
LED	Light emitting diode (used for indicator lights)
SELV	Safety extra low voltage
TCP/IP	Transmission control protocol/Internet protocol

Related Products

For more information about related products, refer to:

- *XW Pro Inverter/Charger Owner's Guide (part number: depends on configuration - see <http://solar.schneider-electric.com/>)*
- *Conext XW+ Inverter/Charger Owner's Manual (part number: depends on configuration - see <http://solar.schneider-electric.com/>)*
- *Conext Automatic Generator Start (AGS) Owner's Guide (part number: 975-0307-01-01)*
- *Conext System Control Panel (SCP) Owner's Guide (part number: 975-0298-01-01)*
- *Conext SW Inverter/Charger Owner's Guide (part number: depends on configuration - see <http://solar.schneider-electric.com/>)*
- *Conext MPPT 60 150 Solar Charge Controller Operation Guide (part number: 975-0400-01-01)*
- *Conext MPPT 80 and MPPT 100 Solar Charge Controller Operation Guide (part number: 990-6214)*
- *Conext Battery Monitor Owner's Manual (part number: 975-0691-01-01)*

Related Information

You can find more information about Schneider Electric's Solar products, as well as its services at <http://solar.schneider-electric.com/>.

Contents

Safety Information	2
Audience	5
About	6
Purpose	6
Scope	6
Firmware Revision	6
Abbreviations and Acronyms	6
Related Products	7
Related Information	7
Overview	12
Introduction	13
Compatible Xanbus™ Components	13
Material List	14
Physical Features	16
Power Button Operation	17
LED Indicator Operation	17
26-pin Connector Pinouts	18
Types of InsightFacility Networks	19
Power Sources for the InsightFacility	19
InsightFacility Web User Interface	20
Installation	22
Choosing a Location	23
Materials and Tools Required	24
Mounting the InsightFacility	25
DIN Rail Mount	25
Connecting the InsightFacility to the Xanbus Network	25
Connecting the InsightFacility to the Internet	27
Turning On the InsightFacility	29
Turning Off the InsightFacility	30
Power Cycling	30
Getting Started	32
Using the InsightFacility Web App via Wi-Fi Access Point (AP)	33
Enabling Wi-Fi Station	33
Web Security	35
Configuring the InsightFacility	36
Logging in to the InsightFacility Web Application	37
User Access Levels	38

Changing the Password	39
Changing InsightFacility Settings	41
Plant Setup	41
Changing the Time	42
Import and Export Settings	42
Units	43
Install Package	43
Restarting the InsightFacility	44
Upgrading Firmware	46
Installing InsightFacility Upgrades From a USB Drive	46
Installing InsightFacility Upgrades Remotely	46
Upgrading Other Device Firmware	47
Configuring Devices	50
Connecting and Configuring Modbus Devices	51
Modbus TCP Settings	52
Removing a Modbus Device	53
Changing Device Settings	54
Device Association	56
Cloud Settings	57
Configuring an AC-Coupled System	58
Configuring the Grid Code Region	58
Enabling California Rule 21	60
Monitoring	64
Monitoring LED Indicators	65
Startup	65
Monitoring the Power Plant	65
Troubleshooting	68
Events	69
Specifications	72
Electrical Specifications	73
Physical Specifications	73
Features	74
Regulatory	74
FCC Regulatory Compliance	74
ISED Regulatory Compliance	75
Simplified EU Declaration of Conformity	76
Schneider Electric Products that Work with the InsightFacility	76
Dimensions	77

Installing the InsightFacility Security Certificate	78
Root Certificates	79

1 Overview

What's in This Chapter?

Introduction	13
Compatible Xanbus™ Components	13
Material List	14
Physical Features	16
Power Button Operation	17
LED Indicator Operation	17
26-pin Connector Pinouts	18
Types of InsightFacility Networks	19
Power Sources for the InsightFacility	19
InsightFacility Web User Interface	20

Introduction

The InsightFacility is a multi-function communication device that provides an overall view of system performance for residential power monitoring systems. It also provides a communications gateway between a network of Xanbus™-enabled devices and Modbus devices. Operators can configure the InsightFacility system and monitor performance with third party software packages and building management systems.

Note: Depending on your access level, you may not be able to see all of the screens described in this document. For more information, see *User Access Levels*

 WARNING
<p>HAZARD OF ELECTRIC SHOCK, EXPLOSION, ARC FLASH, AND FIRE</p> <ul style="list-style-type: none">■ Connect only to Safety Extra Low Voltage (SELV) circuits and limited power sources.■ All wiring must be done by qualified personnel to ensure compliance with all applicable installation codes and regulations.■ For Indoor Use Only.■ Do not disassemble. No user serviceable parts inside.■ Do not dispose of the internal battery in a fire or hot oven. Do not crush or cut the internal battery. Follow proper disposal procedures as outlined by your local codes.■ Do not subject the InsightFacility to extremely high ambient temperature or extremely low air pressure as flammable liquid or gas may leak from the battery. <p>Failure to follow these instructions can result in death, serious injury, or equipment damage.</p>

Other features of the InsightFacility include:

- Compatibility—connects directly to Xanbus-enabled devices
- Real-time clock—keeps time for the entire system
- Non-volatile memory—preserves the latest InsightFacility settings if power is interrupted or network communication is disrupted.
- Firmware storage and upgrade capability—uses the InsightFacility to upgrade or downgrade firmware for Xanbus-enabled devices on the network.
- Cloud storage capability—Save and synchronize settings with the InsightFacility cloud service.

Compatible Xanbus™ Components

The InsightFacility works with several Schneider Electric products including:

- Conext XW Pro Inverter/Charger
- Conext XW+ Inverter/Charger

- Conext Automatic Generator Start (AGS)
- Conext System Control Panel (SCP)
- Conext SW Inverter/Charger
- Conext MPPT 60 150 Solar Charge Controller
- Conext MPPT 80 600 Solar Charge Controller
- Conext MPPT 100 600 Solar Charge Controller
- Conext Battery Monitor

For details on specific models supported, see *Electrical Specifications on page 73*. The InsightFacility supports up to a maximum of 20 devices on a Xanbus network depending on the device types.

Material List

Figure 1 Material list

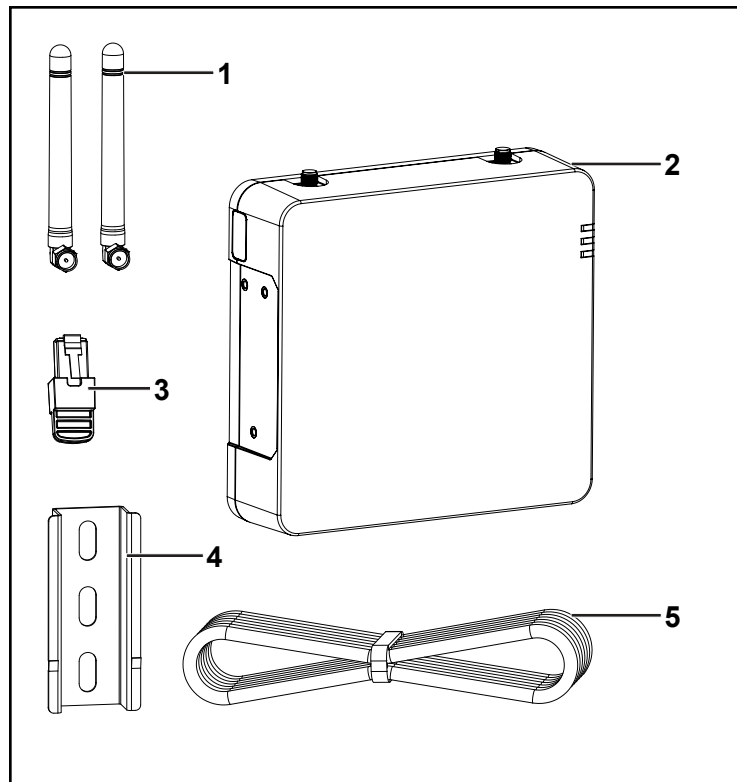

NOTE:

- Do not discard the packaging box.
- The Wi-Fi password is printed on the unit.
- Install the antennas before turning on the unit.

1	Removable antennas
2	InsightFacility unit
3	Network terminator

4	75 mm DIN rail
5	Ethernet cable (CAT5e)
not shown	<ul style="list-style-type: none">• BMS CAN terminator• 26-pin connector (see <i>Physical Features on page 16</i>)
not supplied	Power adaptor: Manufacturer: CUI P/N: SMI18-12-V-P5 Description: AC-DC Power Supply, 12Vdc Output Voltage, 1.6A dc Output Current

Physical Features

The following illustration shows the InsightFacility. The tables in the following sections contain descriptions of the connectors, indicators, and data ports on the InsightFacility.

Figure 2 Ports, buttons, and indicators

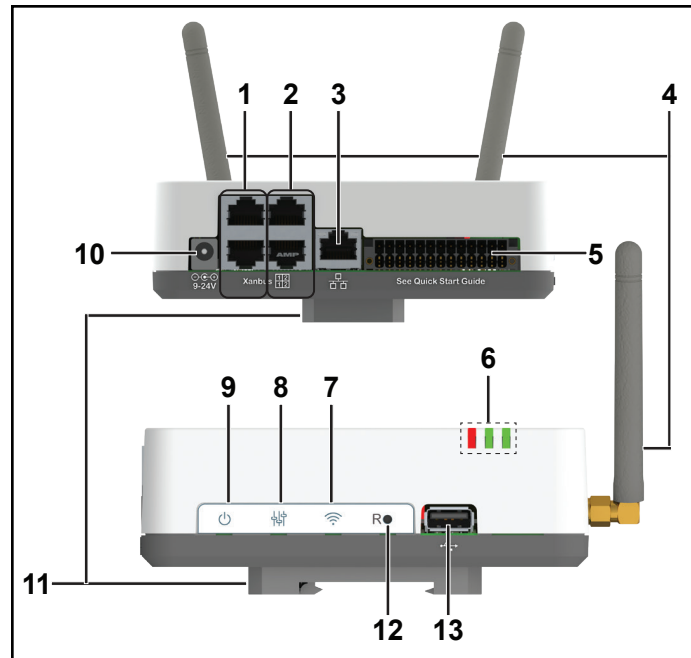

1	Xanbus ports 1	1st pair of Xanbus ports used for Xanbus communications
2	Xanbus ports 2	2nd pair of Xanbus ports used for Xanbus communications
3	Ethernet port	Use to connect to the internet via an Ethernet cable.
4	Antenna	Adjustable antenna for Wi-Fi transmission and reception
5	26-pin port	Use for connecting the 26-pin connector.
6	LED indicators	LED indicators are used for signifying device, communication, and monitoring statuses.
7	Wi-Fi button	Press and hold to turn on or turn off Wi-Fi setup network.
8	Settings button	Press to enter device configuration mode.
9	Power button	Press to enable/disable the InsightFacility.
10	Power port	Use for connecting the AC/DC power plug.
11	DIN rail clip (detachable)	Use for attaching the device to a 35mm EN50022 DIN rail. The clip can be detached and re-attached to one of the narrow sides of the device.
12	Reset pinhole button	Press to reset the InsightFacility.
13	USB port	Use for firmware updates only. Do not use to charge USB devices.

Power Button Operation



Table 1 Power button operation

Press and hold duration	Number of beeps	InsightFacility operation
3 seconds	1	InsightFacility will restart
6 seconds	2	InsightFacility will shutdown
9 seconds	3	User settings will be reset and InsightFacility will restart
12 seconds	4	Factory default settings will be reset and InsightFacility will restart

LED Indicator Operation

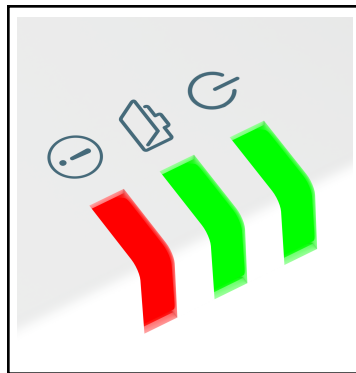
Figure 3 Ports, buttons, and indicators



	Green	Power	The InsightFacility is powered on.
	Green	Memory	Device is logging data to internal memory when flashing.
	Red	Event	Devices on the Power system have events to report.

26-pin Connector Pinouts

Figure 4 26-pin connector

	Bottom Row
2	9–24VDC power input
4	GND
6*	12VDC digital input 1
8*	12VDC digital input 2
10	ISO1 CAN GND
12	ISO1 CAN L
14	ISO1 CAN H
16	ISO2 RS485 GND
18	ISO2 RS485 1A
20	ISO2 RS485 1B
22	ISO2 RS485 GND
24	ISO2 RS485 2A
26	ISO2 RS485 2B

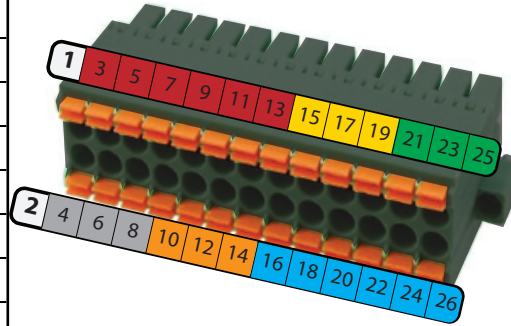

	Top Row
1	GND
3*	0–10VDC analog input 1
5*	0–10VDC analog input 2
7	GND
9*	4–20mA input 1
11*	4–20mA input 2
13	GND
15*	Relay 1 NO
17*	Relay 1 COM
19*	Relay 1 NC
21*	Relay 2 NO
23*	Relay 2 COM
25*	Relay 2 NC

* These pins are currently reserved for future functionality, check sesolar.com for updates.

Types of InsightFacility Networks

The InsightFacility can interface with different LAN devices using wired or wireless connections, so you can configure your Xanbus devices and monitor your power system performance.

- InsightFacility on Xanbus (two separate networks can be supported)
- InsightFacility on Modbus (via the 26-pin connector)
- InsightFacility on Local Area Network (LAN, via Ethernet or Wi-Fi)
When the InsightFacility is part of a LAN, you can access the InsightFacility web user interface from a computer on the same LAN via a wireless or wired LAN connection.

An Ethernet connection is required between the InsightFacility and a router and computer for configuring the InsightFacility.

Power Sources for the InsightFacility

The InsightFacility consumes an average of 2 W under most operating conditions and up to 10 W maximum. The power sources connected to the InsightFacility must be capable of providing this power requirement.

There are three power sources for the InsightFacility:

- AC/DC power adapter (supplied)
- Xanbus-enabled device via CAT5 or CAT5e cable (Xanbus cable)
- 9–24 V DC power input connections on the 26-pin connector

All three sources can be used alone or simultaneously. Typically, the AC/DC power adapter (supplied) is used as a primary source with either a Xanbus connection or the 26-pin connector as secondary sources. See *"Physical Features"* on page 16 for connection locations.

WARNING

ELECTRICAL SHOCK AND FIRE HAZARD

Connect only to Safety Extra Low Voltage (SELV) circuits and limited power sources.

Failure to follow these instructions can result in death, serious injury, or equipment damage.

Safety Extra Low Voltage (SELV) is a designation that refers to a circuit in which the voltages within the circuit and from the circuit to ground have values that are not a shock hazard, under both normal and single fault conditions.

In the InsightFacility, the SELV circuits and their intended connections are:

- The supplied AC/DC power adapter connected to the power port of the InsightFacility.
- Xanbus communications and power which come from SELV circuits on Xanbus-enabled Schneider products.
- 9–24 V DC power input connections which must be SELV and are connected to the InsightFacility via the 26-pin connector.
- Ethernet circuits or Class 2 circuits (Class 2 is a 24V, 100VA limited circuit).

InsightFacility Web User Interface

This section describes the elements of the web-based user interface for the InsightFacility. This interface is used to check the status of the InsightFacility, configure the communications options, monitor and log data for your network, and perform upgrades. The menu bar contains icons for going to the home screen or setup screen, linking to the Schneider Electric Web site, and closing or logging out of the web user interface.

Correct operation of the web user interface has been verified with the following browsers:

- Google Chrome™ 78.x or later
- Microsoft® Windows® Internet Explorer® 11.476 or later
- Safari® 5.x or later

Important: JavaScript and cookies must be enabled in your Web browser for the interface to function.

To access the web user interface, log in with a user name and password. For more details see *Logging in to the InsightFacility Web Application on page 37*.

Figure 5 Web user interface

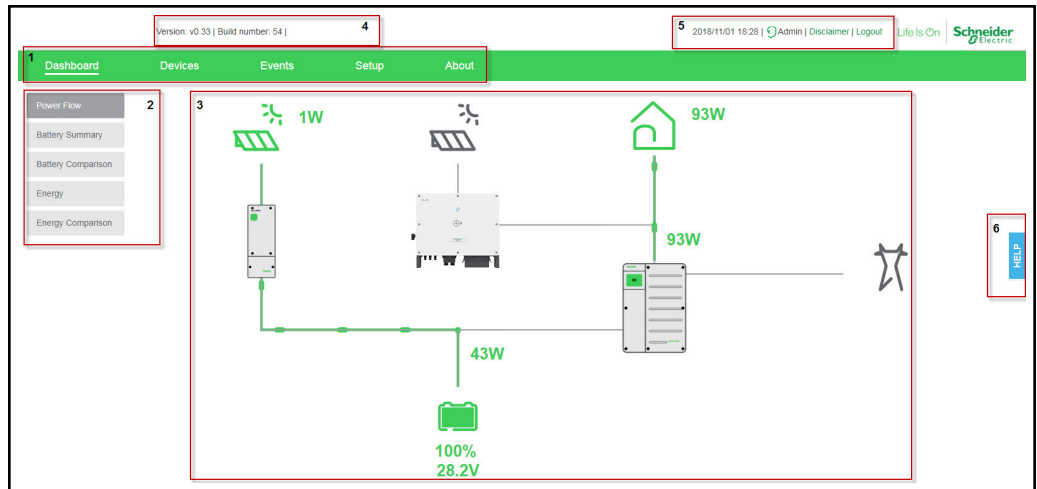

1	Main menu bar – displays major menu items including the Dashboard, Devices, Events, and Setup commands. It includes About , which shows InsightFacility device information.
2	Sub-menu tabs – displays sub-menu items expanding commands associated with the major menu items.
3	Main display area
4	Web app version and build number
5	Information bar – displays the system date, time, and user type. Also, contains a link to the Disclaimer page and Logout.
6	Floating Help tab

2 Installation

What's in This Chapter?

Choosing a Location	23
Materials and Tools Required	24
Mounting the InsightFacility	25
DIN Rail Mount	25
Connecting the InsightFacility to the Xanbus Network	25
Connecting the InsightFacility to the Internet	27
Turning On the InsightFacility	29
Turning Off the InsightFacility	30
Power Cycling	30

Choosing a Location

Figure 6 Location choices

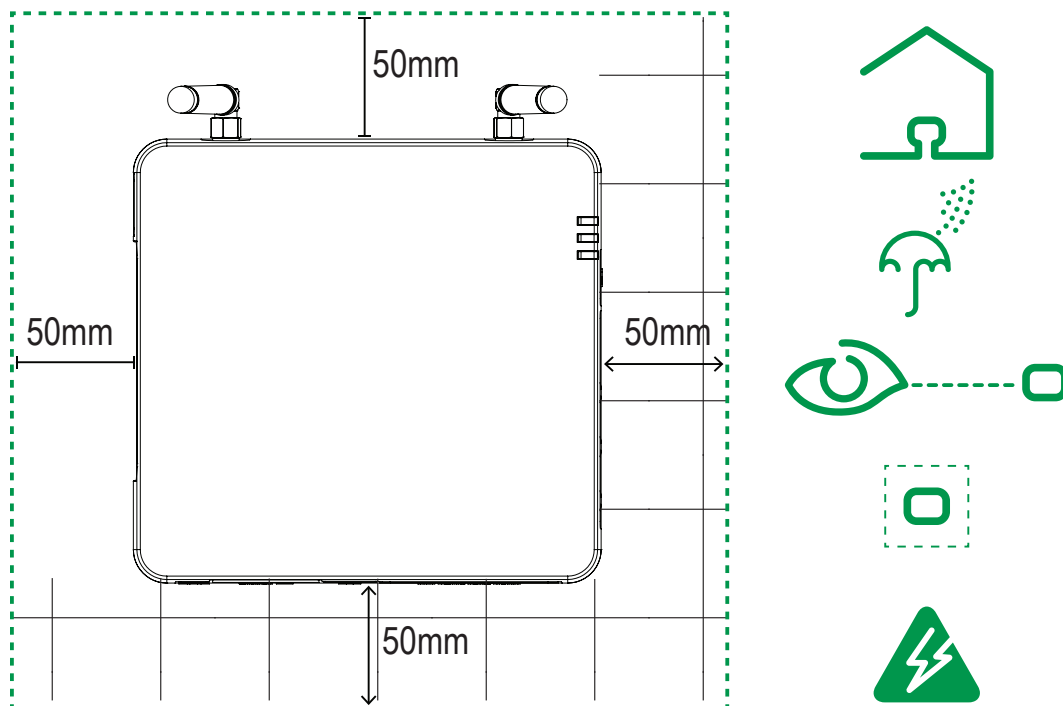

- Choose a clean, dry, easily accessible location indoors.
- If you mount the InsightFacility on a wall, the recommended height is at eye-level so that you can clearly see the LED indicators and have easy access to the data and communication ports.
- All of the ports on the InsightFacility are accessible from the sides of the device when mounted on a wall or DIN rail. Clearance of at least 2 inches (50 mm) around the device is needed to allow for the bending radius of cables that connect to the InsightFacility.
- You should not run cables through conduits that can be exposed to lightning strikes. The following are recommended maximum cable lengths in a InsightFacility system:
 - 131 feet (40 m) Total Xanbus network
 - 328 feet (100 m) Router to InsightFacility
 - 164 feet (50 m) Modbus Master (RS 485) to InsightFacility

Materials and Tools Required

The following materials are supplied in the Conext InsightFacility package:

- One InsightFacility unit
- One InsightFacility Quickstart Guide
- One AC/DC power supply adapter
- One CAT5e Ethernet cable (7-ft)
- One 26-pin connector
- One 75 mm DIN rail

The following materials and tools are not supplied but are required to complete the installation:

- CAT5e Ethernet cable(s)
- Modbus network cables(s)
- Wire stripper
- Ferrules
- Screwdriver set
- Pliers
- Diagonal cutter or heavy duty scissors

Mounting the InsightFacility

DIN Rail Mount

To mount the InsightFacility on the DIN Rail:

1. Use a standard 35-mm “top hat” DIN rail (EN50022).
2. You may choose to move the mounting clip to the side as shown.

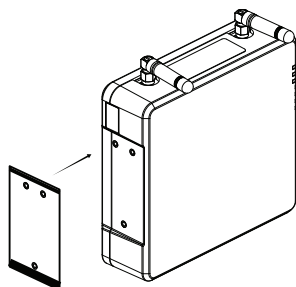

3. Attach the device to the DIN rail. Hook the bottom catch of the clip onto the rail, pull up a little to retract the bottom catch and hook the top catch of the clip onto the rail.

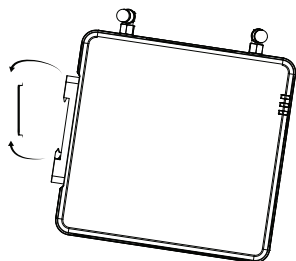

4. Connect the wiring and cables.

Connecting the InsightFacility to the Xanbus Network

To connect the InsightFacility to the Xanbus network:

1. Connect the InsightFacility to the Xanbus network using daisy chain configuration.
 - a. Xanbus components can be arranged in any order.
 - b. The left connectors are *Xanbus 1* and the right connectors are *Xanbus 2*.
 - c. Do not connect two end devices together to form a closed loop configuration.
2. Use a network terminator at both ends of the network. See *Figure 7*.
 - a. Both networks require two Xanbus terminations; *Xanbus 1* and *Xanbus 2*, if the second network is used. *Xanbus 2* does not need terminators if it is not used.
3. Do not interconnect two separate Xanbus networks, meaning, do not daisy chain one Xanbus network with another.
 - a. Not intended to be used in two separate inverter systems.
 - b. Use only one pair of Xanbus ports for the daisy chain.
 - c. If you only have one Xanbus network use *Xanbus 1*.

- d. If you have two separate Xanbus networks connect the second network to *Xanbus 2*.
- e. Devices on the *Xanbus 1* network will not communicate with devices on the *Xanbus 2* network.
- f. See *Figure 7* for *Xanbus 1* pair of ports - one top and one bottom.

NOTICE

EQUIPMENT DAMAGE

- Do not connect a Xanbus cable plug into the Ethernet port on the InsightFacility.
- Connect only to Xanbus ports and use the network terminators to each end device in the daisy chain.
- Do not connect *Xanbus 1* and *Xanbus 2* together as the system will become unstable.

Failure to follow these instructions can result in equipment damage.

Figure 7 Sample Xanbus network

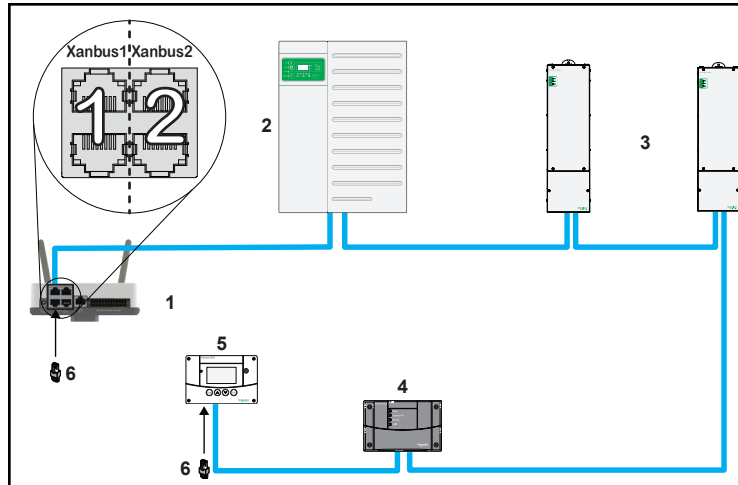

1	InsightFacility unit
2	Conext XW Pro
3	MPPT 80 600
4	Conext AGS (automatic generator start)
5	Conext SCP (system control panel)
6	Network terminators

NOTE: This Xanbus 1 network is for illustration purpose only.

Connecting the InsightFacility to the Internet

Before connecting a computer and router to the InsightFacility, make sure it meets the following prerequisites.

- Microsoft® Windows® 7 or later
- Mac OS® X 10.4.8. or later
- Google Chrome™ 78.x or later
- Microsoft® Windows® Internet Explorer® 11.476 or later
- Safari® 5.x or later
- JavaScript and cookies must be enabled in your web browser.
- Router - the network router must be able to supply DHCP addresses automatically to connected devices. If your network router does not support automatic DHCP, refer to your network router's user guide or contact your system administrator.

To connect the InsightFacility to a Computer on an Ethernet Network:

NOTICE

EQUIPMENT DAMAGE

- Do not connect an Ethernet cable from the InsightFacility to the MODEM port on the network router.
- Do not connect an Ethernet cable plug into a Xanbus port on the InsightFacility.

Failure to follow these instructions can result in equipment damage.

1. Make sure the computer and network router are turned on and the InsightFacility is not turned on. Make sure the network router selected has DHCP enabled.
2. Connect one end of an Ethernet cable to the computer's network port.
3. Connect the other end of the Ethernet cable to a vacant Ethernet/LAN port on the network router.
4. Connect one end of the Ethernet cable (supplied) to the LAN port on the network router.
5. At this stage, the network router should be on, but the LED showing port activity on the router will not show any indication.
6. Connect the other end of the Ethernet cable to the InsightFacility.
7. At this stage, the Ethernet cable should be the only cable plugged into the InsightFacility.

Figure 8 Ethernet connection (LAN)

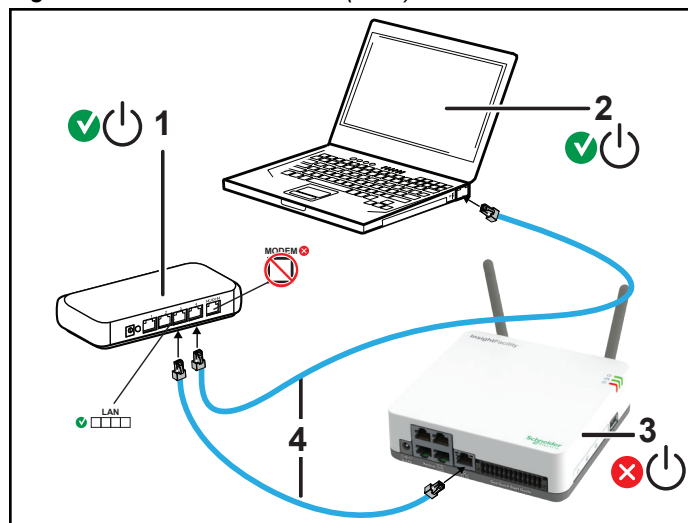

1	Router/modem
2	Laptop
3	InsightFacility unit
4	Ethernet cables

Turning On the InsightFacility

Before turning on the InsightFacility, you must connect it to a power source.

Figure 9 Power connections and button

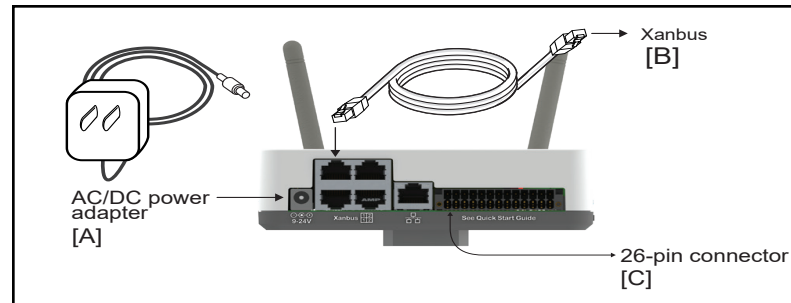

NOTE: In the 26-pin connector, pin 1 connects to a 9-24VDC source and pin 2 connects to GND Power input. See "26-pin connector" on page 18.

To turn on the InsightFacility:

1. Select a power source to the InsightFacility. You can choose either of the following:
 - a. Plug the **(A)** AC/DC power adapter into the AC wall outlet
 - b. Connect the InsightFacility to the Xanbus network **(B)** using Ethernet cables
 - c. Provide 9–24 VDC power via by connecting to a power input source via the 26-pin connector **(C)**

NOTE: An external power supply is not needed if the InsightFacility is connected to a Conext XW+ inverter, XW Pro inverter, MPPT-80, or MPPT-100 device.

2. Connect **(A)**, **(B)**, or **(C)**'s connector to InsightFacility's Power port for **(A)**, Xanbus port for **(B)**, or terminal block for **(C)**, respectively.
3. Connect **(A)**'s power plug to an AC wall outlet, connect **(B)**'s other Xanbus cable connector to a Xanbus port on a Xanbus device, or connect **(C)**'s pins 1 & 2 to an energy-limited DC source (9–24VDC).
4. Observe the LED indicators and wait for the Power LED to light up (solid). The InsightFacility is now turned on.
5. Proceed to "Logging in to the InsightFacility Web Application" on page 37.

⚠ WARNING**PHYSICAL INJURY HAZARD**

Xanbus is a valid power source for the InsightFacility. However, for the first time set-up, using Xanbus as a power source is not recommended. the InsightFacility clock will override the other Xanbus devices' clocks and could trigger unintentional time-based events. Therefore, DO NOT connect the InsightFacility to the Xanbus network prior to setting up the internal clock of the InsightFacility. Refer to *Time Setup on page 1* for instructions. If Xanbus is the only source powering the InsightFacility, after installation verify the time settings in all devices.

Failure to follow these instructions can result in death, serious injury, or equipment damage.

Turning Off the InsightFacility

To turn off the InsightFacility:

- Press the Power button according to the settings in *Table 1 on page 17* or use the web user interface to shut down the unit and turn it off.

Figure 10 Power button

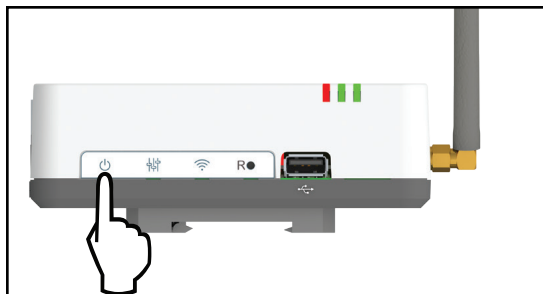

Power Cycling

To power cycle the InsightFacility:

1. Turn the InsightFacility OFF.
 - a. Press and hold the Power button according to the settings in *Table 1 on page 17* or use the web user interface.
 - b. Remove the power connections to the InsightFacility.
2. Wait ten seconds before the next step.
3. Ensure that there is no USB thumb drive inserted in the USB Host port.
4. Turn the InsightFacility ON.
 - a. Plug and connect the InsightFacility to a power source.

3 Getting Started

What's in This Chapter?

Using the InsightFacility Web App via Wi-Fi Access Point (AP)	33
Enabling Wi-Fi Station	33
Web Security	35
Configuring the InsightFacility	36
Logging in to the InsightFacility Web Application	37
User Access Levels	38
Changing the Password	39
Changing InsightFacility Settings	41
Plant Setup	41
Changing the Time	42
Import and Export Settings	42
Units	43
Install Package	43
Restarting the InsightFacility	44
Upgrading Firmware	46
Installing InsightFacility Upgrades From a USB Drive	46
Installing InsightFacility Upgrades Remotely	46
Upgrading Other Device Firmware	47

Using the InsightFacility Web App via Wi-Fi Access Point (AP)

Wi-Fi Access Point allows you to connect your PC or tablet directly to the InsightFacility. This is typically only used for first-time configuration. **NOTE:** This procedure is not about connecting to a local area network (LAN) via Wi-Fi (for more information, see *Enabling Wi-Fi Station*).

In order to establish a user interface with InsightFacility, a direct Wi-Fi connection is necessary. The following are the pre-requisites:

- Laptop with Microsoft® Windows® 7 or later, Mac OS® X 10.4.8. or later
- Wi-Fi setting for the laptop is enabled
- Web browser such as Google Chrome™ 78.x or later, Microsoft® Windows® Internet Explorer® 11.476 or later, Safari® 5.x or later
- JavaScript and cookies must be enabled in your web browser.

Figure 11 Wi-Fi connection requirements

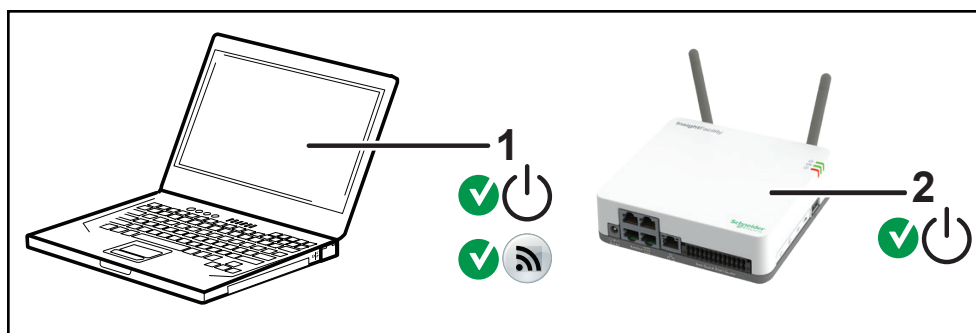

1	Laptop
2	InsightFacility unit. Wi-Fi password label is on the back panel.

To connect:

1. Make sure the laptop and InsightFacility are turned on.
2. Verify that Wi-Fi is enabled on the laptop.
3. Open your laptop's Wi-Fi settings, then look for and connect to the InsightFacility SSID. For example, you may look for something similar to **InsightFacility_XXXXXX**.
4. Enter the **Password** when prompted.

NOTE: The password is printed on a label on the back panel of the InsightFacility unit.
5. Proceed to *Logging in to the InsightFacility Web Application*.

Enabling Wi-Fi Station

When the InsightFacility is connected to a wireless router, it is in Wi-Fi Station mode. This procedure describes how to connect to your home Wi-Fi network through the InsightFacility desktop app. Before proceeding, verify that you are connected to the InsightFacility via the Wi-Fi Access Point instead of a cabled Ethernet (LAN) connection

(see *Using the InsightFacility Web App via Wi-Fi Access Point (AP)*). **NOTE:** Wi-Fi Station cannot be used unless the LAN cable is disconnected.

To enable Wi-Fi Station:

1. Go to **Setup > Network > Network settings**.
2. Select your network. If you do not see your network, go to step 4.
3. Enter the network password. When you enter the correct password, the network name and icon will turn green and move to the top of the list, and a green checkmark will appear beside the name. **NOTE:** If you have an Ethernet cable plugged in, the checkmark will remain beside **Ethernet connection**, and you will not be able to successfully connect to the network you selected in step 2. Unplug the Ethernet cable, connect your device via the Wi-Fi Access Point, and repeat the steps above.

Figure 12 Wi-Fi Station connection

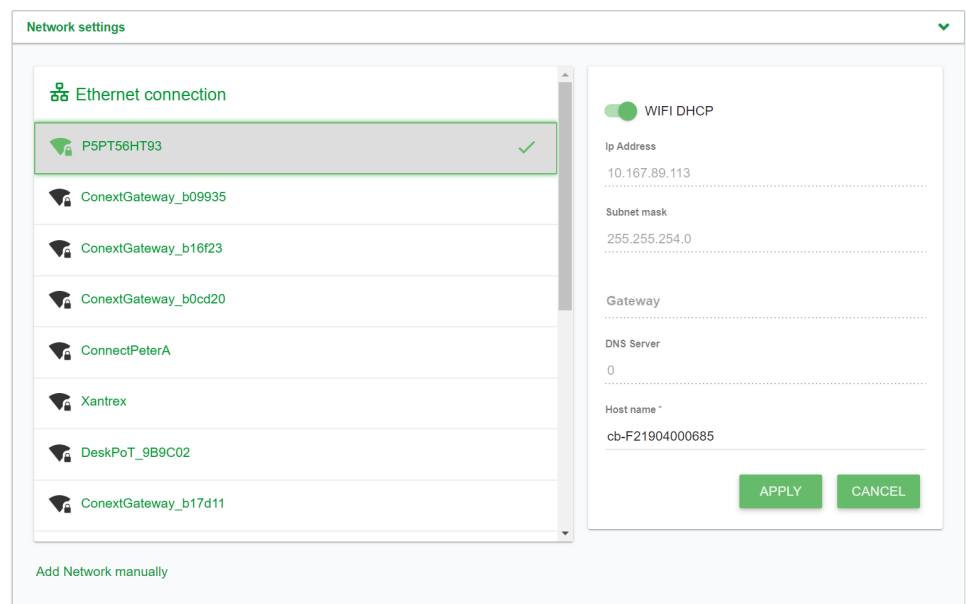

4. If you do not see your network, add the network manually:
 - a. Below the list of networks, click **Add Network manually**.

Figure 13 Adding a network manually

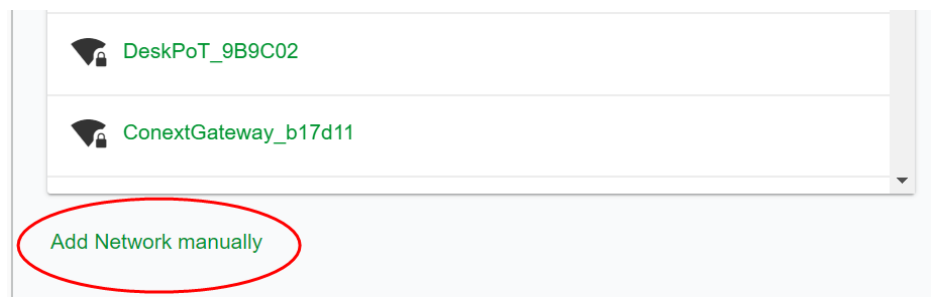

- b. Enter the SSID (network name).

- c. Enter the network password.
- d. Click **Connect**.

Web Security

When you access the InsightFacility web user interface you may see a warning stating that the web page is not trusted or the web page is not secure. This occurs because the InsightFacility security certificate is not installed on your computer's operating system. You can elect to proceed anyway, if you are on a private local area network. Alternatively, you may choose to download the web security certificate from the InsightFacility and install it on your PC. See *"Installing the InsightFacility Security Certificate" on page 1* for instructions on how to do this using the Chrome web browser on Windows. Other browsers will have similar mechanisms for installing the certificate.

Configuring the InsightFacility

To complete InsightFacility setup, you must successfully complete the procedures in *Installation on page 22*. Make sure the InsightFacility is connected, the Power LED is on, and the Event LED is off. Your Xanbus devices should still be in standby mode.

When you initially log in to the web user interface, most of the setup information appears automatically with their default values. Some information must be changed (such as passwords), some information can be modified as needed, and some information can only be modified by a qualified IT professional.

The following items are part of the InsightFacility configuration process:

Primary

1. Log in - see *"Logging in to the InsightFacility Web Application" on the next page*
2. Change the password - see *"Changing the Password" on page 39*
3. Set plant site information - see *"Plant Setup" on page 41*
4. Set the system time - see *"Time Setup" on page 1*

Optional/Occasional

1. Configure general device settings - see *"Changing Device Settings" on page 54*
2. Upgrade the device firmware - see *"Upgrading Firmware" on page 46*

Logging in to the InsightFacility Web Application

1. If you have connected the InsightFacility via Wi-Fi Access Point, go to the IP address `https://192.168.100.1` to access the web user interface.
2. If you have connected the InsightFacility via Ethernet or Wi-Fi Station, use the following steps:
 - a. Insert a blank USB drive into the InsightFacility USB port.
Ensure there are no firmware upgrade files on this USB drive.
 - b. After the InsightFacility beeps twice, remove the USB drive.
 - c. Insert the USB drive into your laptop USB port.
 - d. Copy the HTML file to your laptop.
 - e. Remove the USB drive from your laptop.
 - f. Open the HTML file and click the link to the IP address of the InsightFacility.
3. Bookmark this address. **Important:** The web address is a locally and privately assigned (LAN) device address that is also protected by a firewall.
4. Select your User Name. Select **Admin**.

NOTE: A maximum of two Admin users can be logged in to one InsightFacility at the same time. For more information, see *User Access Levels*.
5. Enter your Password. The initial password is **Admin123**.
6. **Important:** When prompted, change the initial password immediately to protect the device from unauthorized users and to enable changes to device settings.

NOTE: To perform administrative functions such as a firmware update, set User Name to **Admin**. Settings are disabled until the initial password is changed.

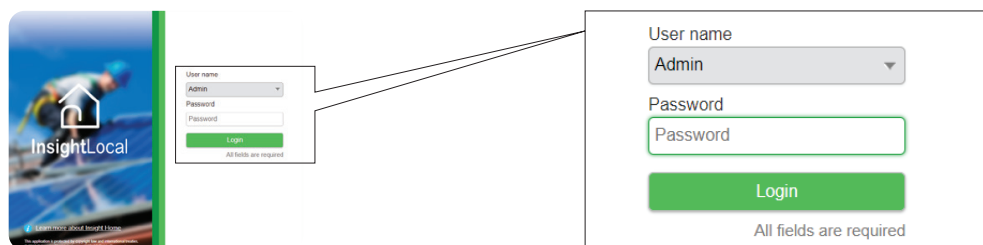

7. Change the InsightFacility SSID and network password:
 - a. Go to **Setup > Network > Wifi Access Point Settings**
 - b. (Optional) Replace the current Wi-Fi network name under the **SSID** field with an appropriate name. You are limited to 64 alphanumeric characters including symbols.
 - c. Replace the current password under the **Password** field with 10 or more alphanumeric characters including symbols.
 - d. Click **Apply** to save the new password and/or SSID.

User Access Levels

The following types of user accounts are available:

Account type	Description	Accounts allowed/InsightFacility
Admin	Can configure the InsightFacility and attached devices.	2
User	Can view the InsightFacility dashboard and the status of attached devices, but cannot configure the InsightFacility or attached devices. The password for this account is used to connect to a InsightFacility through the mobile app.	5
Guest	Can only view the InsightFacility dashboard.	1

Changing the Password

What to expect when logging in for the first time:

- When logging in to the web application for the first time, either as **Admin** or **User** or **Guest**, the system will automatically ask you to change the password from the factory default **Admin123** or **User123** or **Guest123**, respectively.

Important: To protect your privacy, change all default passwords when you login for the first time.

Figure 14 Message box to change password

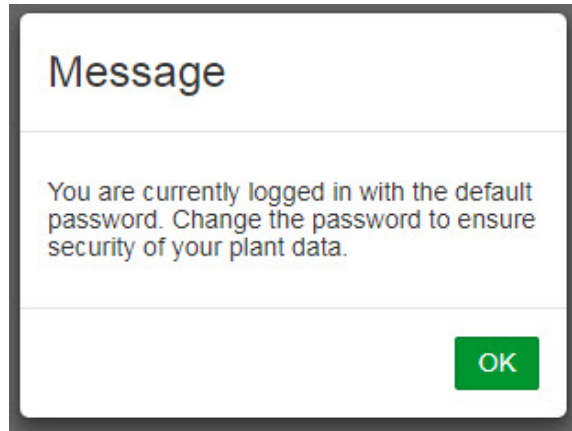

- Click **OK** and follow the instructions to change the password. Passwords must:
 - Be at least 10 characters in length
 - Contain at least one upper case character
 - Contain at least one lower case character
 - Contain at least one digit
 - Contain at least one symbol

Figure 15 Password screen

- You may have to log in again after changing the initial password.

To change the password after the initial log in:

Figure 16 Change password setting

1. Click **Setup > Manage Passwords > Change Passwords**.
2. Select the **User name** type. **Note:** Admin-level can change all passwords. User-level can change User and Guest passwords. Guest-level cannot change any passwords.
 - Admin
 - User
 - Guest
3. Enter the **Old password**.
4. Enter the **New password**.

5. Enter the **Confirm password**.
6. Click **Apply**. Your settings will be immediately applied.

Changing InsightFacility Settings

The procedures for configuring the other InsightFacility Settings are described in the following sections.

To change InsightFacility settings:

1. In the main menu bar, click **Setup > Configuration**.
The **Configuration** settings appear in the main display area.
2. Click any of the following settings.
 - a. Plant setup - see *Plant Setup on page 41*
 - b. Time setup - see *Time Setup on page 1*
 - c. Import & export settings - see *Import and Export Settings on page 42*
 - d. Units - see *Units on page 43*
 - e. Modbus settings - see *Modbus Settings on page 1*
 - f. Restart InsightFacility - see *Restarting the InsightFacility on page 44*
 - g. Install package - see *Install Package on page 43*
3. With only a few exceptions, you may save a setting by clicking **Apply** or ignore changes by clicking **Cancel**.
That portion of the window expands to display the change options for that setting. The size and content of the expanded window varies depending on the setting type.

Plant Setup

It is recommended to name the plant site to distinguish it from other installations in your power system.

Figure 17 Plant setup screen

To enter plant information:

1. Click **Setup > Configuration > Plant setup**.
2. Enter a **Friendly name**. Choose a name that can easily identify the plant site to your customers.
3. Enter the **Installed AC capacity (kW)**.

4. Enter the **Installed year**.
5. Click **Apply**. Your settings will be immediately applied.

Changing the Time

In order for the Cloud interface to work properly, you must set the correct time and time zone. You can choose to use the network time for your system.

Figure 18 Time setup screen

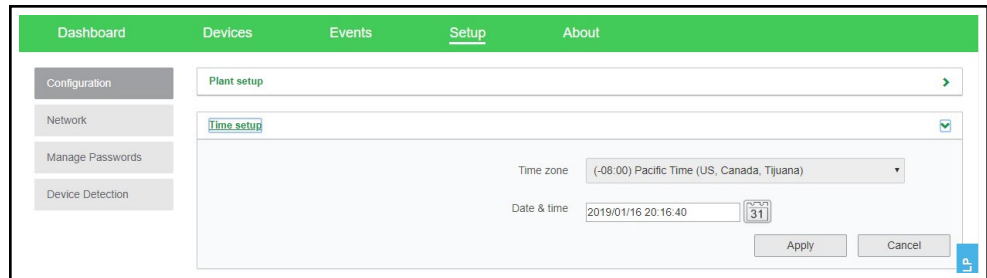

To change the InsightFacility time:

1. Click **Setup > Configuration > Time setup**.
2. Select the **Time zone**. This time setting overrides settings on other devices in the system.
3. Select the **Date & time**.
4. Click **Apply**. Your settings will be immediately applied.

Import and Export Settings

This command setting allows you to either export the configuration of this InsightFacility to another InsightFacility unit or import the configuration of another InsightFacility to supersede this InsightFacility unit.

Figure 19 Import & export setup screen

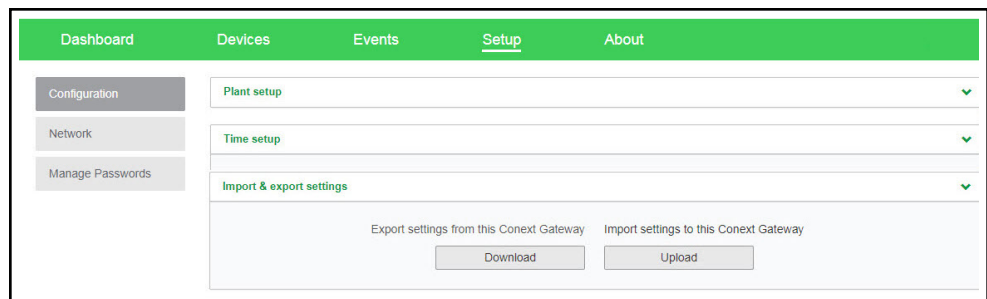

To export settings:

1. In the main menu bar, click **Setup > Configuration**.
The **Configuration** settings appear in the main display area.
2. Click **Import & export settings**.
 - a. Click **Download**. The compressed configuration file *usersettings.zip* will be automatically saved to the **Downloads** folder of the browser.

- b. If necessary, you may copy this file to an external drive and later import it to a different InsightFacility device.

To import settings:

1. In the main menu bar, click **Setup > Configuration**.
The **Configuration** settings appear in the main display area.
2. Click **Import & export settings**.
 - a. Click **Upload**.
 - b. Locate the compressed configuration file *usersettings.zip* from a local directory or an external drive.
 - c. Click **Restart now** to finish the importing of the configuration file.

Units

This setting allows you to change the standard unit of measurement used in solar irradiance, temperature, and wind speed.

Figure 20 Units setup screen

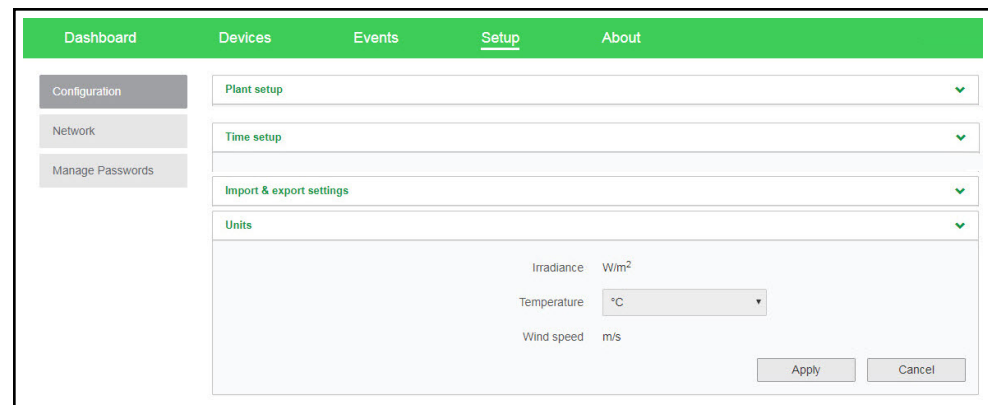

To change units:

1. In the main menu bar, click **Setup > Configuration**.
The **Configuration** settings appear in the main display area.
2. Click **Unit**.
Currently, only **Temperature** can be changed to either celsius or fahrenheit.
3. Save the settings by clicking **Apply**.
Alternatively, ignore the changes by clicking **Cancel**.

Install Package

To install a InsightFacility upgrade remotely:

1. From the InsightFacility Web Application home page, go to **Setup > Configuration > Install Package**.

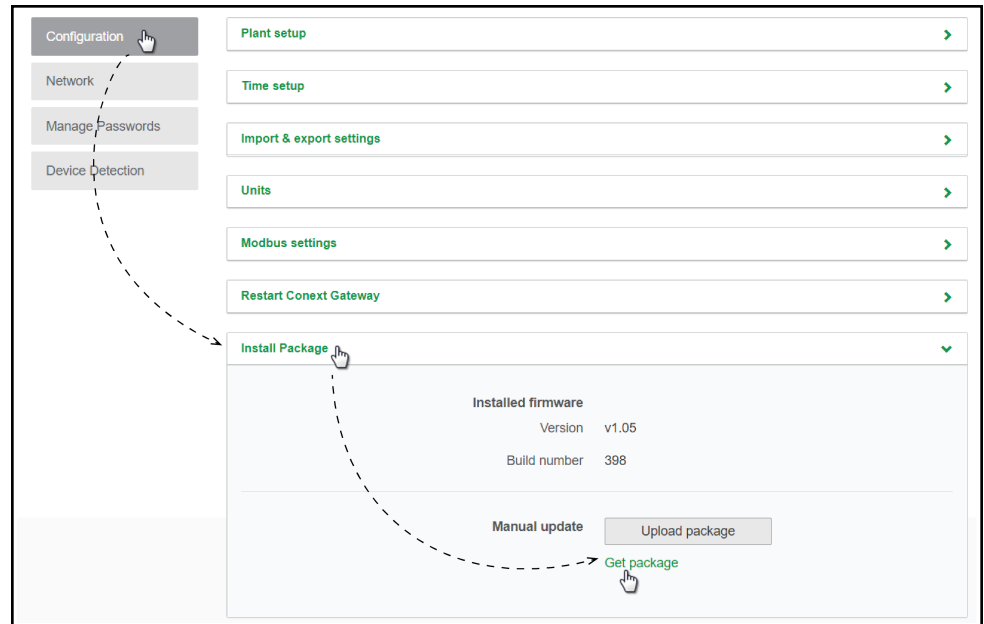

2. Download the firmware package.
 - a. Click **Get package**. This will take you to the InsightFacility product webpage.
 - b. From the product webpage, go to **DOWNLOADS > Firmware**.
 - c. Search for the latest firmware package from the list and click it to begin downloading.
 - d. Save the `.epkg` file to a local directory.
3. Go back to the InsightFacility Web Application.
4. Click **Upload package**.
5. Search and select the firmware package (`.epkg` file) you saved in a local directory from the InsightFacility product webpage.
6. Click **Open** from the Windows dialog. The upgrade begins automatically.
7. As the firmware package is transferred to the InsightFacility, progress is indicated in percentage, and a message screen indicates when the file transfer has been completed successfully.
8. When prompted, reboot the InsightFacility. See *Restarting the InsightFacility on page 44*.

Restarting the InsightFacility

You are allowed to restart, reset the configuration, or return the InsightFacility to all of the original factory settings remotely from the web user interface or by pressing and holding the Power button according to the settings in *Table 1 on page 17*.

Figure 21 Restart InsightFacility screen

Choose what to do in the web user interface:

1. Click **Setup > Configuration > Restart InsightFacility**.
2. Click any of the action buttons depending on the kind of reset you want to perform.
 - **Restart InsightFacility** – will execute a soft restart of the InsightFacility unit.
 - **Reset configuration** – will execute a reset of InsightFacility settings, including network configuration, and plant setup. This action does not affect the configuration of connected devices.
 - **Reset to factory settings** – will execute a complete return to factory settings including forgetting all detected devices, removing data logs, removing event logs, and resetting all configuration.
3. Follow the succeeding instructions.

Upgrading Firmware

You can perform firmware upgrades for your InsightFacility and Xanbus-enabled devices when they are available for download.

There are three upgrade procedures, namely:

- *"Installing InsightFacility Upgrades From a USB Drive" below*
- *"Installing InsightFacility Upgrades Remotely" below*
- *"Upgrading Other Device Firmware" on the next page*

Installing InsightFacility Upgrades From a USB Drive

Follow the procedure below to change the InsightFacility firmware to an updated version.

To update the firmware:

1. Using a laptop computer, format a USB drive and open a web browser.
 2. Go to <http://solar.schneider-electric.com> and download the latest InsightFacility firmware version (contained in a ZIP file).
 3. Navigate to **Products > Battery Based Inverters > Accessories > InsightFacility**
 4. Click **DOWNLOADS > Firmware > FWYYYYMMDD-InsightFacility VX.XX BNXXXX (865-0329).ZIP**
 5. Pick the firmware version (V) with a higher number and also a higher build number (BN). The ZIP file is approximately 35 MB.
 6. Extract the .epkg file from the ZIP file into the root directory of the USB drive (supplied with the unit).
 7. To initiate the update to the firmware:
 - a. Insert the USB drive into the port on the InsightFacility.
 - b. The InsightFacility will beep once and the LED will blink while the the firmware is copied to the InsightFacility and the upgrade is performed. This can take 5–10 minutes.
 - c. If the update takes more than 10 minutes, make sure that the .epkg file is copied correctly into the root directory.
- Important:** Once the USB drive is inserted, Do not turn off the InsightFacility.
8. Once the firmware upgrade is done, the InsightFacility emits two beeps. and the LED indicator stops blinking.
 9. Remove the USB drive.
 10. Manually reboot the InsightFacility using the power switch to complete the firmware upgrade process.

Installing InsightFacility Upgrades Remotely

For full instructions, see *"Install Package" on page 43.*

Upgrading Other Device Firmware

It is possible to upgrade a device's firmware through the InsightFacility web application.

NOTICE
<p>RISK OF EQUIPMENT DAMAGE</p> <ul style="list-style-type: none"> ■ Consult the device's Owner's Guide when changing the device's settings. ■ Make sure the device connected on the Xanbus or Modbus network is in Standby mode before changing settings. ■ Do not change any settings unless you are familiar with the device. <p>Failure to follow these instructions can result in equipment damage.</p>

Figure 22 Sample Device Overview screen - List display

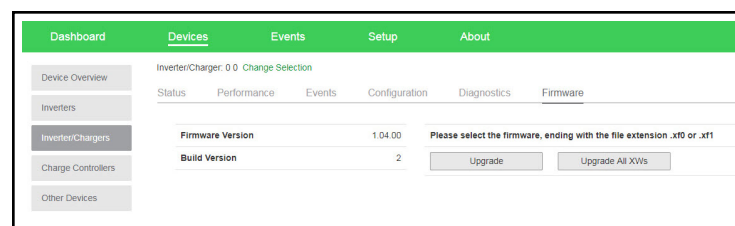

To obtain the firmware package:

1. From a laptop computer, open a web browser.
2. Go to <http://solar.schneider-electric.com> and download the latest version of the correct device firmware (contained in a ZIP file).
3. Navigate to the appropriate product page.
4. Click **DOWNLOADS > Firmware > FWYYYYMMDD-Product NameVX.XX BNXXXX (Product Number).ZIP**.
5. Pick the firmware version (V) with a higher number and also a higher build number (BN). The ZIP file is approximately 6 MB.
6. Extract the .xf0 file from the ZIP file into a folder on the local drive.

To upgrade a device firmware:

1. In the main menu bar, click **Devices**.
2. Put the device in to Standby mode first (if the device is an inverter, this will stop power production).
 - a. Click a device you want to put in to Standby mode.
 - b. Click **Configuration > Controls**.
Note that **Controls** may be called differently such as **AGS Control**.
 - c. Search for the control setting **Operating Mode**.
 - d. Select **Standby**.
 - e. Click **Apply**.

3. Click **Firmware** .
4. Click **Upgrade**.
5. Follow the step-by-step upgrade instructions.
6. To upgrade all similar devices in the network, click **Upgrade All**.
7. Follow the step-by-step upgrade instructions.
8. Use the **Operating Mode** menu to put the device back into normal operating mode.

4 Configuring Devices

What's in This Chapter?

Connecting and Configuring Modbus Devices	51
Modbus TCP Settings	52
Removing a Modbus Device	53
Changing Device Settings	54
Device Association	56
Cloud Settings	57
Configuring an AC-Coupled System	58
Configuring the Grid Code Region	58
Enabling California Rule 21	60

Connecting and Configuring Modbus Devices

NOTE: For Modbus map information, contact Schneider Electric.

Connect Modbus wires to pins 16, 18, and 20 (see *Physical Features*), and then complete the following steps in the InsightFacility web application:

1. Go to **Setup > Configuration > Modbus Settings**.
2. Complete the **Serial Port** setup and then click **Apply**.

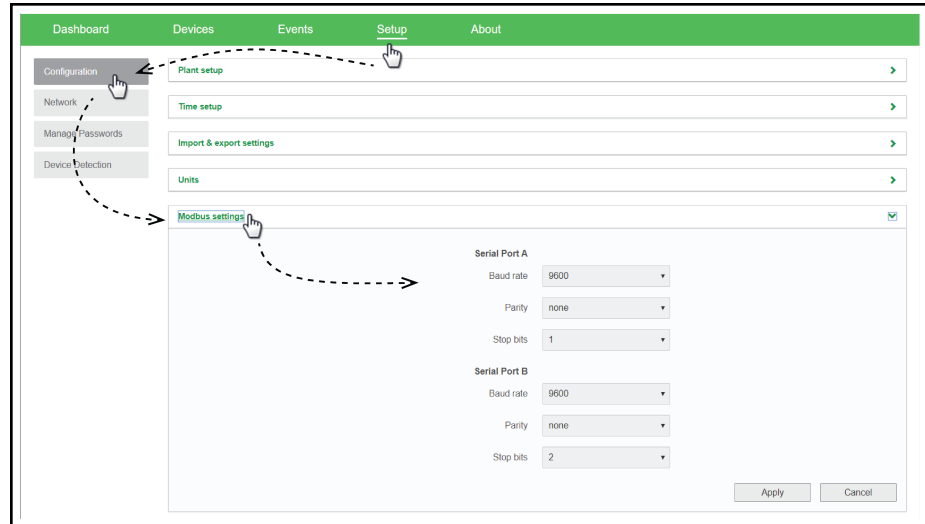

3. Go to **Home > Setup > Device Detection**.
4. Under **Range**, enter a Modbus address range and then click **Detect**.

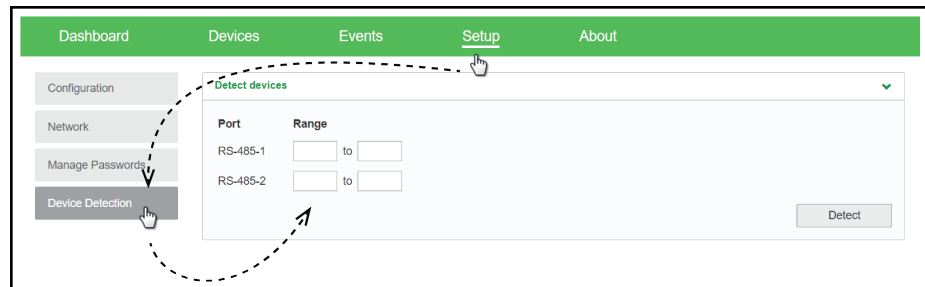

5. Go to **Devices** and then select a device.
6. Go to **Configuration** and configure the device. Repeat steps 5 and 6 for each device.

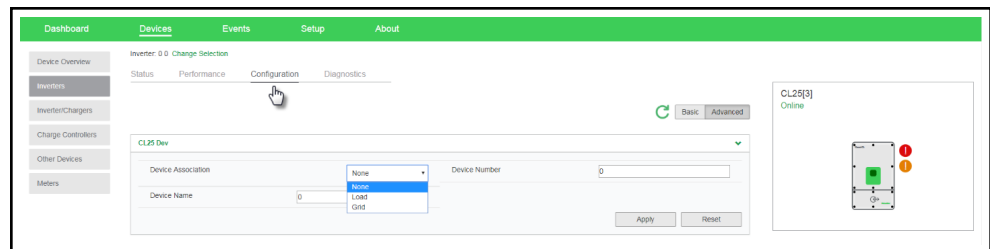

Modbus TCP Settings

Modbus TCP allows an external controller to communicate with the InsightFacility and perform monitoring and control activities.

Important: The Modbus TCP protocol is not secure. **DO NOT** route this protocol over an untrusted public or private network. Ensure adequate cybersecurity protections are enforced on your network. Maintain appropriate firewalls and physical access restrictions.

To enable Modbus TCP:

1. Go to **Setup > Network > Modbus TCP settings**.
2. Slide the toggle switch to the right.
3. Click **Apply**.

Figure 23 Modbus TCP settings

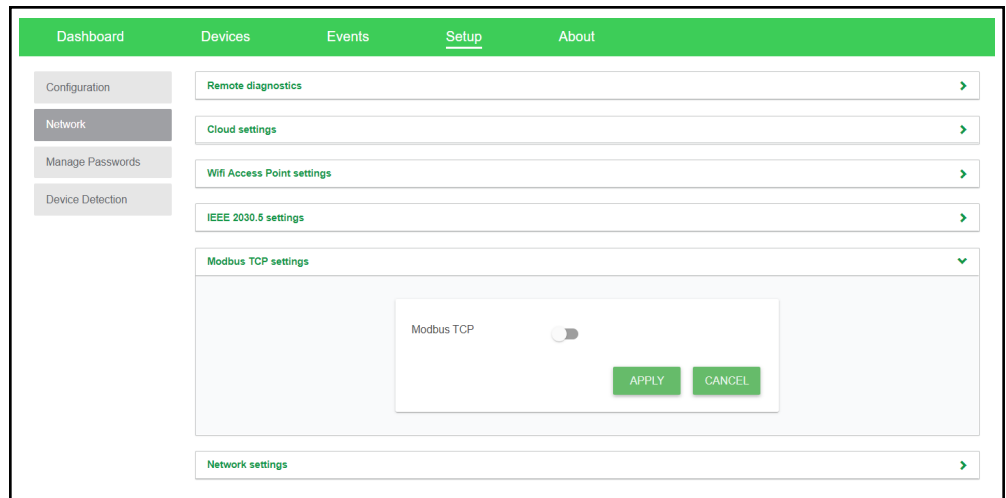

Removing a Modbus Device

To remove a Modbus device from InsightFacility:

1. Disconnect the device from the bus.
2. Log in to the InsightFacility web application.
3. Select the **Devices** tab and then navigate to the Modbus device that you want to remove.
4. Verify that the device is "Offline" and then click on the device.



5. Click **Delete Device**.

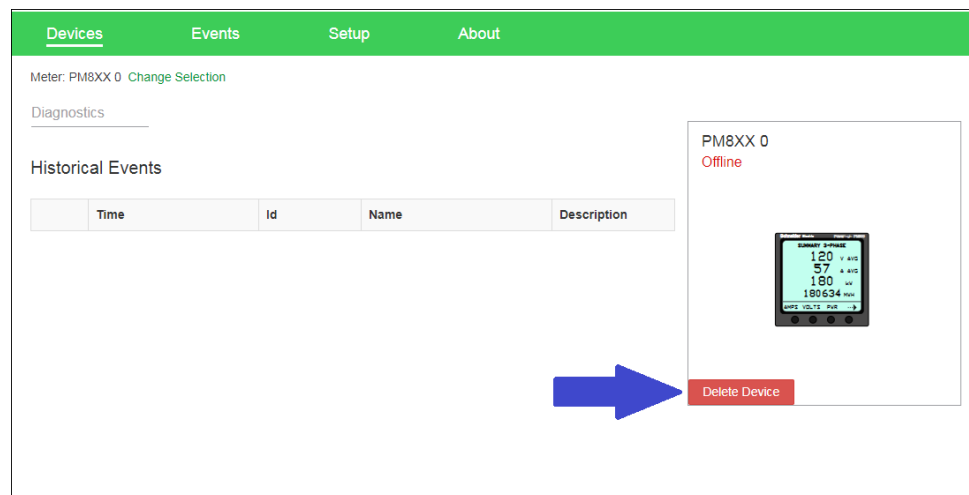

6. In the *Delete Device* dialog, click **Delete**.

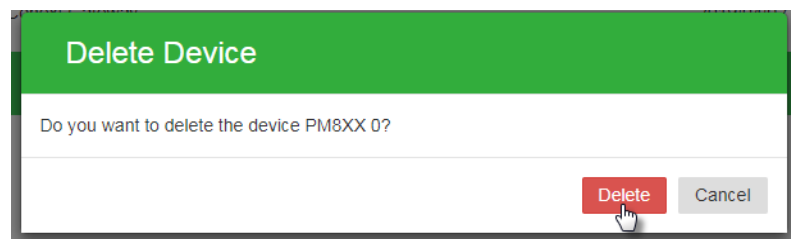

7. Restart your InsightFacility (recommended).

Changing Device Settings

Before making any changes, familiarize yourself thoroughly with the effects of changing the settings of another device.

NOTICE

RISK OF EQUIPMENT DAMAGE

- Consult the device's Owner's Guide when changing the device's settings.
- Make sure the device connected on the Xanbus or Modbus network is in Standby mode before changing settings.
- Do not change any settings unless you are familiar with the device.

Failure to follow these instructions can result in equipment damage.

Figure 24 Sample Device Overview screen - Icons display

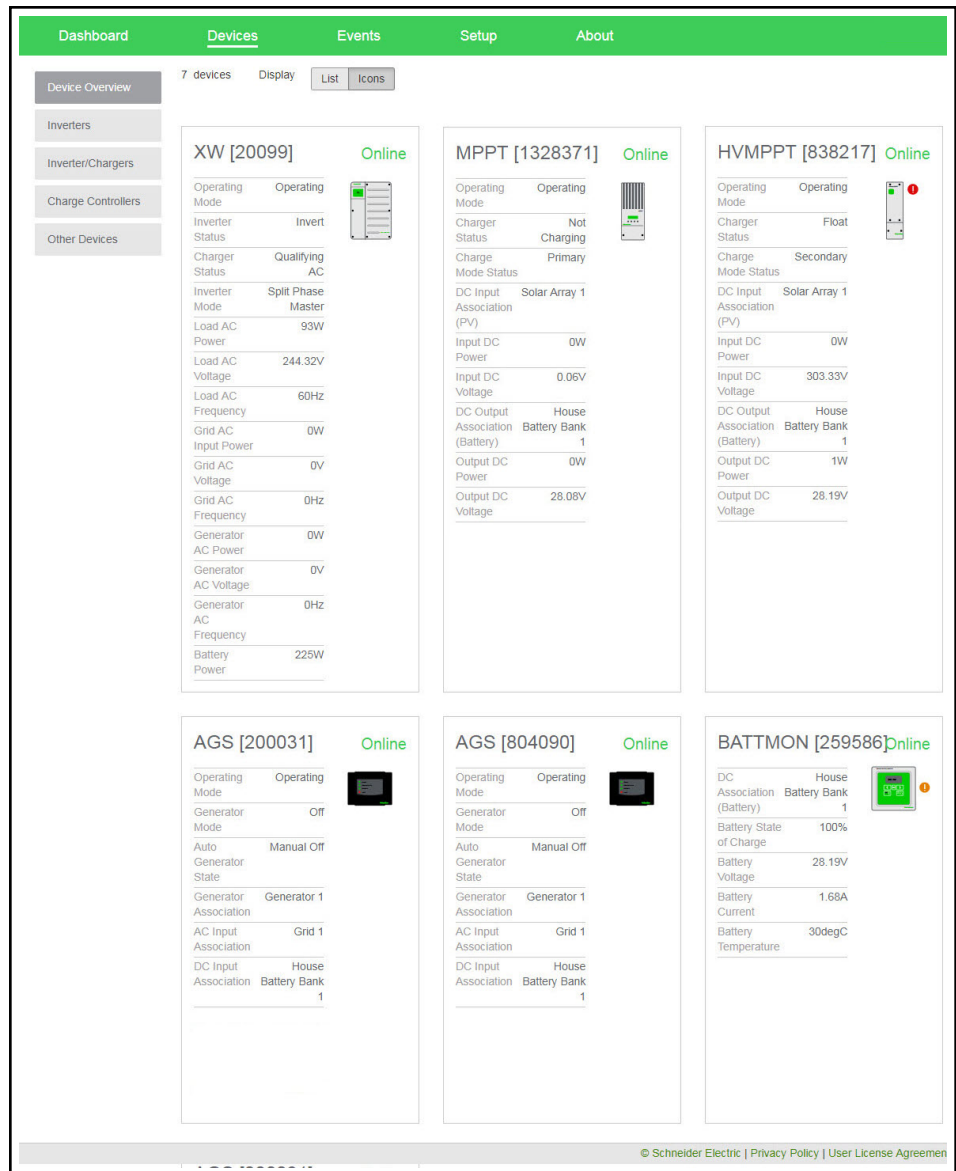
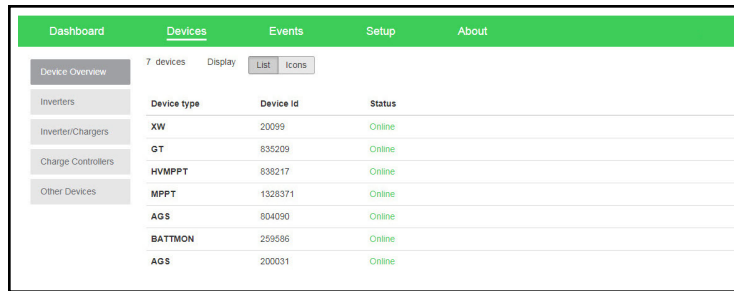

Figure 25 Sample Device Overview screen - List display



Dashboard			
Devices			
Events			
Setup			
About			
7 devices	Display		
	List Icons		
Device Overview			
Inverters	Device type	Device id	Status
Inverter/Chargers	XW	20099	Online
Charge Controllers	GT	835209	Online
Other Devices	HVMPPT	838217	Online
	MPPT	1328371	Online
	AGS	804090	Online
	BATTMON	259586	Online
	AGS	200031	Online

To change a device setting:

1. In the main menu bar, click **Devices**. See *Figure 24* for a sample of the default display of all connected devices.
2. If you want a shorter list of devices, switch to a List display. See *Figure 25*.
3. Put the device in to Standby mode first.
 - a. Click a device you want to put in to Standby mode.
 - b. Click **Configuration > Controls**.
Note that **Controls** may be called differently such as **AGS Control**.
 - c. Search for the control setting **Operating Mode**.
 - d. Select **Standby**.
 - e. Click **Apply**.
4. Click **Configuration**
5. Choose either **Basic** or **Advanced** settings.
6. Click a device setting category. For example, **Inverter Settings** in the case of an inverter device.
7. Change a specific setting by selecting from a drop down list, toggling a switch, or entering a different value.
8. Click **Apply** to save the changes.
9. Use the **Operating Mode** menu to put the device back into normal operating mode.

Device Association

This procedure describes how to set device associations from the InsightFacility web application.

To associate devices:

1. In the main menu bar, click **Devices** and then select the device type from the left menu.
2. Select a device.
3. On the device page, select **Configuration** and then click **Advanced**.
4. Click **Associations** to expand the section.

5. Select the correct association(s) from the drop-down menu(s).
6. Click **Apply**.
7. To verify the associations, select the **Status** tab and confirm that all associations are correct.

Inverter/Charger: XW8548-61 3 [Change Selection](#)

Status Performance Events Configuration Diagnostics Firmware

Inverter Status **Inverter Disabled**

Charger Status **Charger Disabled**

Modbus Address	0	Device Present	Active (data valid)
Inverter Enabled Status	Enabled	Charger Enabled Status	Enabled
Sell Enabled Status	Disabled	Device State	Safe Mode
Inverter Status	Inverter Disabled	Charger Status	Charger Disabled
Active Faults	No Faults	Active Warnings	No Warnings
Battery Association	House Battery Bank 1	DC Voltage	54.7 V
DC Current	0 A	DC Power	0 W
Battery Temperature	N/A	Charge Mode Status	Secondary
AC1 Association (Grid)	Grid 1	AC1 Power	0 W
AC1 L1 Voltage	0 V	AC1 L1 Current	0 A
AC1 L2 Voltage	0 V	AC1 L2 Current	0 A
AC1 Voltage Qualified	Not Qualifying	AC1 Frequency Qualified	Not Qualifying
AC1 Qualified Duration	0 s	AC2 Association (Generator)	None
AC2 Voltage	31.5 V	AC2 L1 Voltage	31.5 V
AC2 L2 Voltage	0 V	AC2 Frequency	0 Hz
AC2 Power	0 W	AC2 L1 Current	0 A
AC2 L2 Current	0 A	AC2 Voltage Qualified	Not Qualifying
AC2 Frequency Qualified	Not Qualifying	AC2 Qualified Duration	0 s
AC Output Association (Loads)	AC Load 1	AC Load Frequency	0 Hz
AC Load Power	0 W	AC Load L1 Voltage	0 V
AC Load L1 Current	0.1 A	AC Load L2 Voltage	0 V
AC Load L2 Current	0 A		

Cloud Settings

To use InsightCloud for remote monitoring and configuration, you must configure the Cloud connection for your InsightFacility. The **Cloud settings** screen can be used to check your Cloud connectivity.

To configure the Cloud connection for your InsightFacility:

1. Go to **Setup > Network > Cloud settings**.
2. Beside “Cloud enable”, select the **Enable** radio button.

The screenshot shows the 'Cloud settings' configuration page. At the top, there are navigation tabs: Dashboard, Devices, Events, Setup (selected), and About. Below the navigation is a sidebar with 'Configuration', 'Network' (selected), 'Manage Passwords', and 'Device Detection'. The main content area is titled 'Cloud settings' and contains the following fields:

- Uniform Resource Name: um dev ogm 000054-Combox-FC6947228521
- Cloud enable: Enable, Disable
- Proxy enable: Enable, Disable
- Proxy URL:
- Proxy port:
- Proxy user name:
- Proxy password:
- Allow remote firmware upgrade: Enable, Disable
- Cloud connection status: (indicated by a green dot)
- Number of transmitted messages: 101
- Number of received messages: 0
- Number of messages failed to send: 0
- Last data transfer time from cloud: 2019-10-07T22:53:38+0000
- Cloud Disconnection Events: 3

At the bottom right, there are 'Apply' and 'Cancel' buttons.

3. If you are setting up the InsightFacility on your home network, a proxy is likely not required. However, if you are using a corporate, or other externally managed network, then proxy settings may be required. To use proxy settings:
 - a. Enter the proxy URL and port number.
 - b. If required, enter the proxy username and password.
 - c. Set “Proxy enable” to **Enable**.
4. Click **Apply**.

Once the InsightFacility is connected to the Cloud, the “Cloud connection status” indicator will change from red to green, and the “Number of transmitted messages” will start to increase. You can also check the “Last data transfer time from cloud” to check the last time your InsightFacility sent a message to the Cloud. This information can be helpful to troubleshoot connectivity issues.

Configuring an AC-Coupled System

This procedure describes how to associate a PV inverter's point of coupling in an AC-coupled system.

To configure an AC-coupled system:

1. In the main menu bar, click **Devices** and then select the device type from the left menu.
2. On the device page, select **Configuration** and then click **Advanced Device Settings**.
3. From the drop-down menu, select either **Load** or **Grid** (depending on how your system is set up).

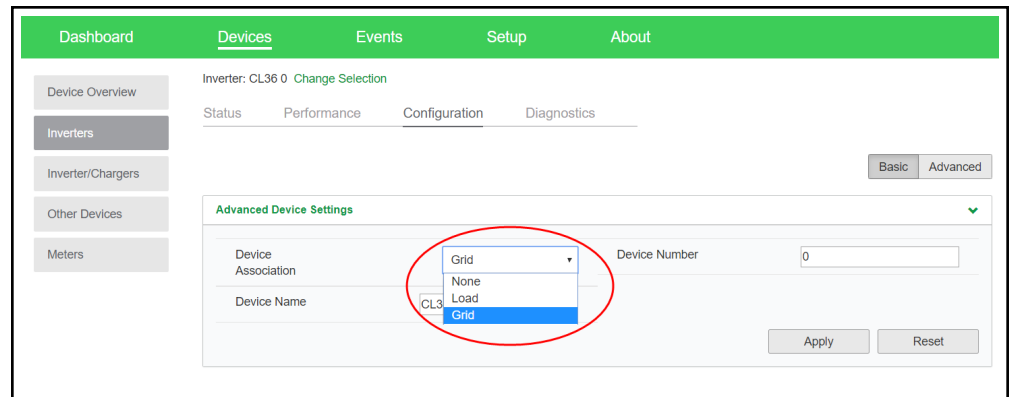

Configuring the Grid Code Region

Note: This procedure is for authorized personnel only. Changing this setting will modify the **Region Settings** for all devices in the system.

To configure the grid code region:

1. Log in to the InsightFacility web application.
2. Go to **Setup > Region Settings**, and type your password.

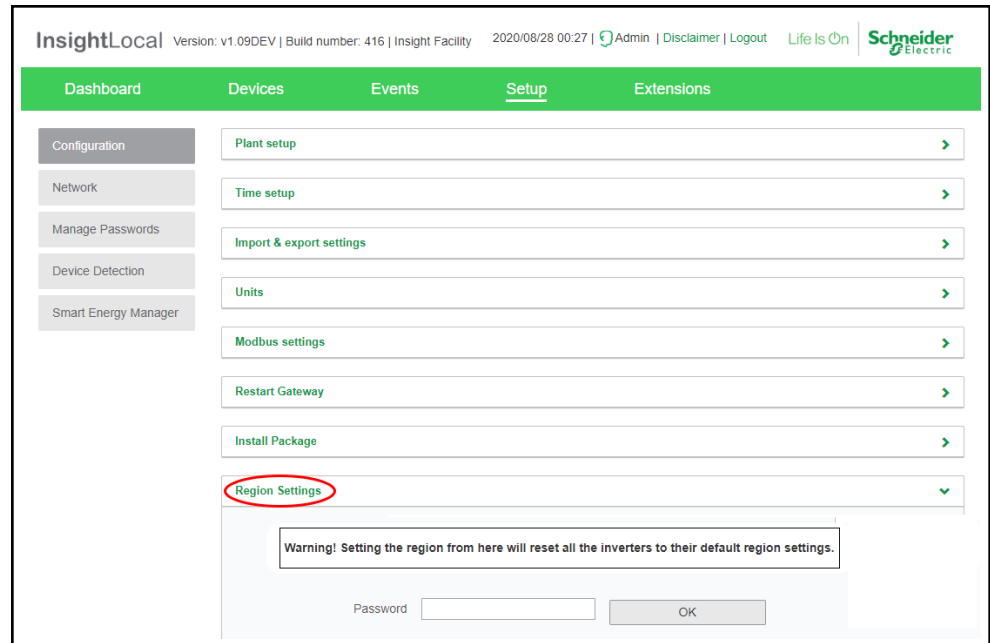

3. Press **OK**.
4. Select a region from the **Select Region** drop-down menu.

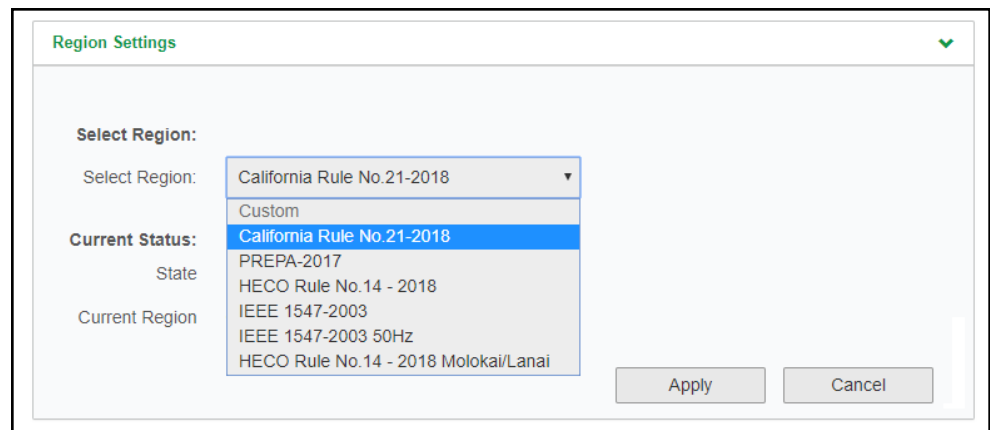

5. Click **Apply**.

To change grid code functions on specific devices:

1. Log in to the InsightFacility web application.
2. Go to **Devices > Inverter/Chargers**, and select your inverter model.
3. Click **Grid Codes**.
4. Go through the options in the **Select Function** drop-down menu and configure the settings below the graph.

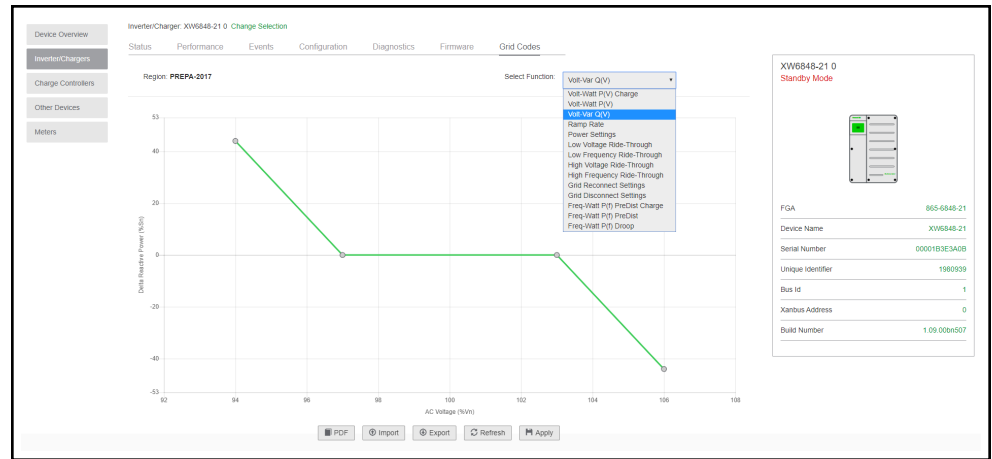

5. Click **Apply**.

Enabling California Rule 21

- Source Requirements Document: RULE 21 Generating Facility Interconnection - Smart Inverter Generating Facility Design and Operating Requirements - Section Hh - Effective July 30, 2017

Instructions for Rule 21 Compliance

To be California Rule 21 compliant, and for CEC compliance, upgrade your unit firmware to Version 1.0 or later, and update the Grid Code region in the InsightFacility desktop app.

Note: This procedure is for authorized personnel only. Changing this setting will modify the **Region Settings** for all devices in the system.

NOTICE

INCOMPATIBLE FIRMWARE

DO NOT use the InsightFacility firmware upgrade package to update the firmware on the Conext XW+. The InsightFacility firmware is not compatible with the Conext XW+.

Failure to follow these instructions can result in equipment damage.

To update firmware:

- Follow the instructions in *Upgrading Other Device Firmware on page 47*.

To update the Grid Code region in InsightFacility:

1. Log in to the InsightFacility web application.
2. Go to **Setup > Region Settings**, and type your password.

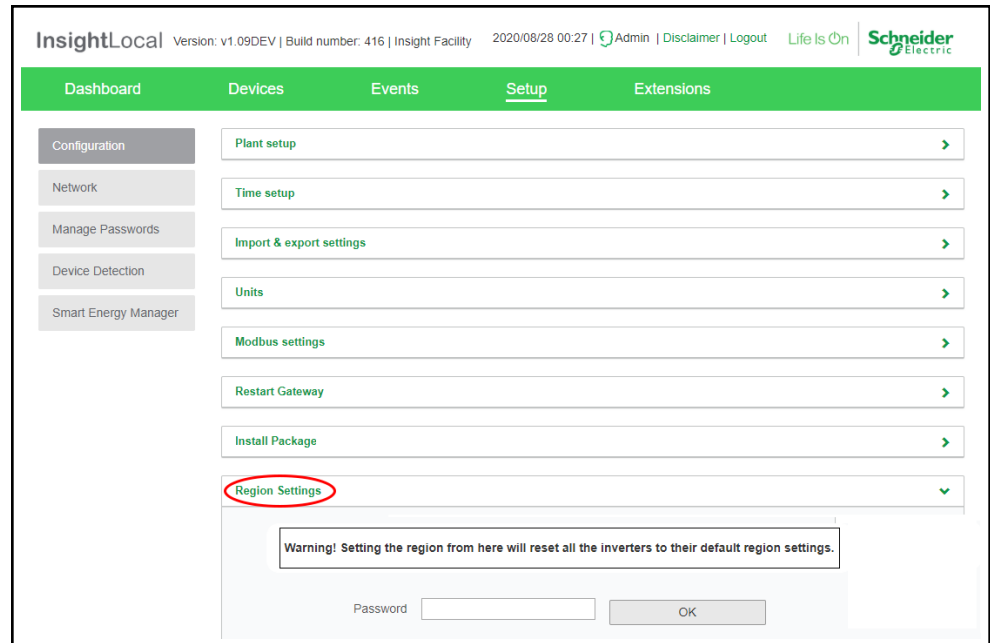

3. Press **OK**.
4. Select **California Rule No 21-2018** from the **Select Region** drop-down menu.

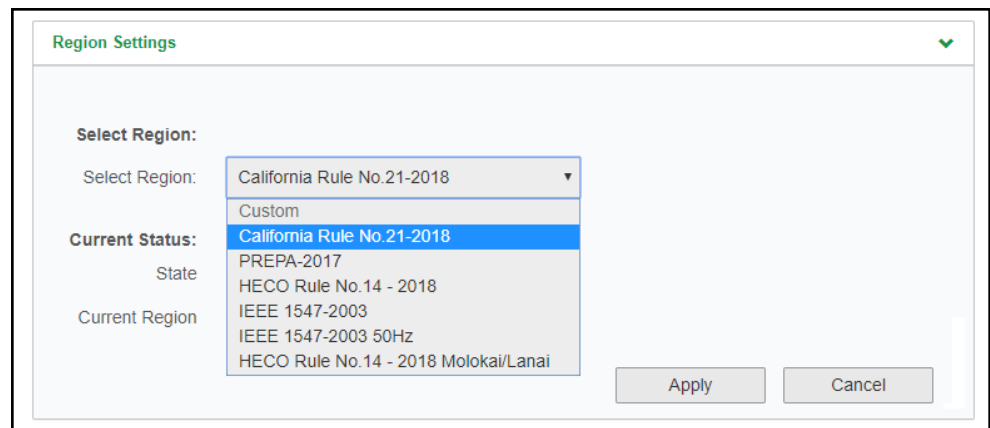

5. Click **Apply**.

To change grid code functions on specific devices:

1. Log in to the InsightFacility web application.
2. Go to **Devices > Inverter/Chargers**, and select your inverter model.
3. Click **Grid Codes**.
4. Go through the options in the **Select Function** drop-down menu and configure the settings below the graph.

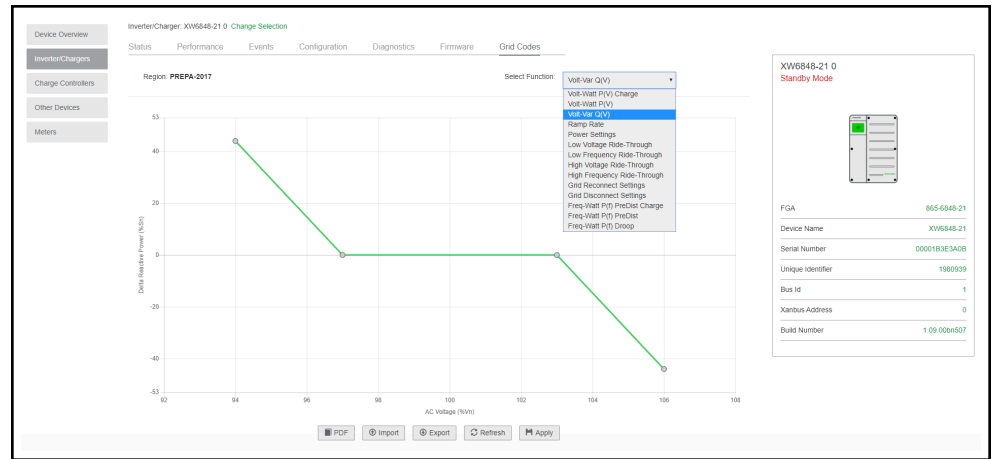

5. Click **Apply**.

5 Monitoring

What's in This Chapter?



Monitoring LED Indicators	65
Startup	65
Monitoring the Power Plant	65

Monitoring LED Indicators

LED indicators allow you to monitor the functioning of the InsightFacility.

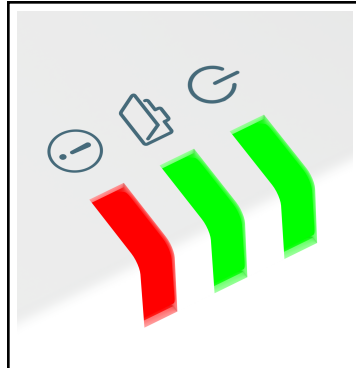
Figure 26 Ports, buttons, and indicators



	Green	Power	The InsightFacility is powered on.
	Green	Memory	Device is logging data to internal memory when flashing.
	Red	Event	Devices on the Power system have events to report.

Startup

The Power LED flashes slowly when the InsightFacility application is loading and flashes quickly during application initialization. Once the InsightFacility is ready, the Power LED turns on (solid). This process takes about two minutes.

Monitoring the Power Plant

You can view the current state of the power plant by viewing the InsightFacility dashboard.

With the **Dashboard**, you can view power flow between the connected devices, battery information, and energy production and consumption.

Figure 27 Dashboard

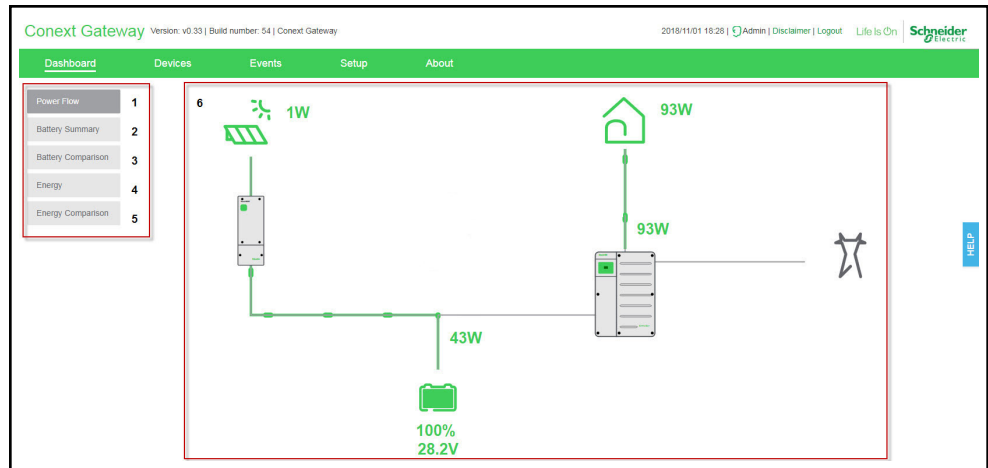

1	Power flow tab – shows an interactive and graphical view of the power plant with its different connected devices.
2	Battery summary tab – shows a historical line graph of four battery metrics such as current, volts, temperature, and state-of-charge (SOC). It shows one battery at a time.
3	Battery comparison tab – shows a historical and comparative line graph of the four battery metrics against all the different batteries.
4	Energy tab – shows a chronological summary of energy that is produced by three sources; solar, grid, and battery. Also shows a chronological summary of energy that is output to four energy consumers; load, grid, battery, and generator.
5	Energy comparison tab – shows a comparative graph between energy input and output.
6	Main display board – shows the different graphical elements of the power plant, the devices, battery, and energy information.

To view the dashboard:

1. After successfully logging in, the very first view to show on the main display board is the **Dashboard - Power Flow**.
2. Click each of the tabs on the left to switch to different views.

6 Troubleshooting

What's in This Chapter?

Events 69

Events

The events detected and monitored by InsightFacility vary in type. The types of events are categorized into warnings and detected faults. Warnings are displayed as orange icons with an exclamation point. Detected faults are displayed as red icons with an exclamation point.

When devices detect an event that usually resolves by itself, it is still reported to InsightFacility and logged. It is logged under **Historical** (see *Figure 29*). However, events that happen repeatedly escalate to a fault or sometimes the device detects a fault, such as a ground fault. When a fault is detected, it is also reported to InsightFacility and logged. If service intervention is required, it is logged under **Active** (see *Figure 28*). It remains there until service is performed. Also, if user intervention is required, such as remotely resetting a device, the event is logged under **Active** and remains there until the user is able to perform the necessary action.

Figure 28 Active events

Event Type	Time	Device Type	Device Id	Id	Name	Description
	2018/08/25 08:47:09 +0100	HVMPPT	838217	82	Network Power Supply Fault	The Network Power Supply has failed. Solution:
	Not Available	GT	835209	54	APS Off	PV Voltage is zero, and grid voltage is within limits (240V AC). Solution:

Figure 29 Historical events

Event Type	Time	Device Type	Device Id	Id	Name	Description
	2018/10/30 00:54:39 +0000	HVMPPT	838217	4	Battery Over Temperature Warning	Cause: The battery is too hot. Solution:
	2018/10/25 07:14:23 +0100	HVMPPT	838217	4	Battery Over Temperature Warning	Cause: The battery is too hot. Solution:
	2018/10/15 21:34:48 +0100	HVMPPT	838217	4	Battery Over Temperature Warning	Cause: The battery is too hot. Solution:
	2018/10/15 08:05:59 +0100	HVMPPT	838217	4	Battery Over Temperature Warning	Cause: The battery is too hot. Solution:
	2018/10/03 02:03:53 +0100	HVMPPT	838217	4	Battery Over Temperature Warning	Cause: The battery is too hot. Solution:
	2018/10/02 19:14:09 +0100	HVMPPT	838217	4	Battery Over Temperature Warning	Cause: The battery is too hot. Solution:
	2018/10/01 14:57:11 +0100	HVMPPT	838217	4	Battery Over Temperature Warning	Cause: The battery is too hot. Solution:
	2018/09/28 18:48:48 +0100	HVMPPT	838217	4	Battery Over Temperature Warning	Cause: The battery is too hot. Solution:
	2018/09/28 03:46:12 +0100	MPPT	1328371	71	DC Over-current shutdown	Cause: DC output current is too high. Solution:
	2018/09/28 03:46:12 +0100	HVMPPT	838217	71	DC Over-current shutdown	Cause: DC output current is too high. Solution:

First Previous 1 2 3 4 5 6 7 8 9 10 Next Last

To view Events:

1. In the main menu bar, click **Events**.
The **Active** events are displayed first in the main display board.

2. Click **Historical** to view events that have been logged and/or resolved.
3. To download a copy of the events, click the **CSV** icon on the lower right hand corner of the main display board.

7 Specifications

What's in This Chapter?

Electrical Specifications	73
Physical Specifications	73
Features	74
Regulatory	74
FCC Regulatory Compliance	74
ISED Regulatory Compliance	75
Simplified EU Declaration of Conformity	76
Schneider Electric Products that Work with the InsightFacility	76
Dimensions	77

Electrical Specifications

NOTE: Specifications subject to change without prior notice.

NOTICE	
EQUIPMENT DAMAGE	
Do not power the unit without first installing the supplied antennas.	
Failure to follow these instructions can result in equipment damage.	
Power Consumption	2 W average / 10 W peak
AC/DC adapter	Input: 100-240 V AC, 50-60 Hz, 0.48 A, Output: 12 V DC, 1.6 A, 5.5 mm outer, 2.1 mm center-positive jack. NOTE: Required when used with the Conext SW.
Xanbus	When connected to Conext XW Pro/XW+ or MPPT 80 600 providing network power
9–24V on 26-pin connector	9–24 V DC, 1 A max input only through pins 1 and 2 Accepts 16–24 AWG pin wire size, wire length should meet local regulations
Operation Frequency	2412–2472 MHz (Europe) 2414–2462 MHz (N. America)
Max. radio frequency power transmitted	17.06 dBm (E.I.R.P., Declaration for EU)

Physical Specifications

NOTE: Specifications subject to change without prior notice.

Weight (device only)	330 g (0.73 lb)
Dimensions (device only) (W × H × D)	138 x 135 x 41 mm (5.4 × 5.3 × 1.6 inches)
Shipping package dimensions	193 × 161 × 105 mm (7.6 × 6.3 × 4.1 inches)
Shipping package weight	800 g (1.7 lbs)
Housing/Mounting system	ABS Plastic / 35-mm DIN rail clip
IP rating / Mounting Location	IP 20, NEMA 1, Indoor only
Status Display	3 x LEDs
Temperature	Operating: -4 to 122 °F (-20 to 50 °C) Storage: -40 to 185 °F (-40 to 85 °C) Maximum case temperature: 140 °F (60 °C)
Humidity	Operating: < 95%, non-condensing Storage: < 95%

Features

NOTE: Specifications subject to change without prior notice.

Programmable dry contact relay	Screw 3-terminal, 16-24 AWG, NC-Com-NO, Form: Class 2, 24 V DC, 4 A max SELV input only
Web-base user interface	Internet Browser
Remote firmware upgrades	Yes (InsightFacility and connected Xanbus devices)

Regulatory

NOTE: Specifications subject to change without prior notice.

EMC immunity	EN61000-6-1 EN 301 489-1, -17	EN 55035
EMC emissions	EN61000-6-3 EN 301 489-1, -17 FCC part 15B	EN 55032 ICES-003
Substances / environmental	RoHS	
FCC ID	Contains 2AODL-CONEXTGTWY	
IC ID	Contains 24209-CONEXTGTWY	
Model number	865-0329	

FCC Regulatory Compliance

This device complies with Part 15 of the FCC Rules. Operation is subject to the following two conditions: (1) this device may not cause harmful interference, and (2) this device must accept any interference received, including interference that may cause undesired operation.

Note: This equipment has been tested and found to comply with the limits for a Class B digital device, pursuant to Part 15 of the FCC Rules. These limits are designed to provide reasonable protection against harmful interference in a residential installation. This equipment generates, uses and can radiate radio frequency energy and, if not installed and used in accordance with the instructions, may cause harmful interference to radio communications.

However, there is no guarantee that interference will not occur in a particular installation.

If this equipment does cause harmful interference to radio or television reception, which can be determined by turning the equipment off and on, the user is encouraged to try to correct the interference by one or more of the following measures:

- Reorient or relocate the receiving antenna.
- Increase the separation between the equipment and receiver.
- Connect the equipment into an outlet on a circuit different from that to which the receiver is connected.
- Consult the dealer or an experienced radio/TV technician for help.

Note: changes or modifications not expressly approved by the party responsible for compliance could void the user's authority to operate the equipment.

RF Exposure Compliance

This equipment complies with FCC radiation exposure limits set forth for an uncontrolled environment. This equipment should be installed and operated with minimum distance 20 cm between the radiator and your body. This transmitter must not be co-located or operating in conjunction with any other antenna or transmitter.

Supplier's Declaration of Conformity

47 CFR § 2.1077 Compliance Information

Unique Identifier:

Trade Name: InsightFacility

Model No.: 865-0335

Responsible Party – U.S. Contact Information

Schneider Electric Solar Inverters USA, Inc.

Suite 318 8700 Turnpike Rd Westminster, CO 80031

<https://solar.schneider-electric.com/>

FCC Compliance Statement

This device complies with Part 15 of the FCC Rules. Operation is subject to the following two conditions: (1) This device may not cause harmful interference, and (2) this device must accept any interference received, including interference that may cause undesired operation.

ISED Regulatory Compliance

This device contains licence-exempt transmitter(s) that comply with Innovation, Science and Economic Development Canada's licence-exempt RSS(s).

Operation is subject to the following two conditions:

1. This device may not cause interference.
2. This device must accept any interference, including interference that may cause undesired operation of the device.

L'émetteur exempt de licence contenu dans le présent appareil est conforme aux CNR d'Innovation, Sciences et Développement économique Canada applicables aux appareils radio exempts de licence. L'exploitation est autorisée aux deux conditions suivantes :

1. L'appareil ne doit pas produire de brouillage;
2. L'appareil doit accepter tout brouillage radioélectrique subi, même si le brouillage est susceptible d'en compromettre le fonctionnement.

This equipment complies with IC RSS-102 radiation exposure limits set forth for an uncontrolled environment. This transmitter must not be co-located or operating in conjunction with any other antenna or transmitter. This equipment should be installed and operated with minimum distance 20 cm between the radiator and your body.

Cet équipement est conforme aux limites d'exposition aux radiations IC CNR-102 établies pour un environnement non contrôlé. Cet émetteur ne doit pas être situé ou fonctionner conjointement avec une autre antenne ou un autre émetteur. Cet équipement doit être installé et utilisé avec une distance minimale de 20 cm entre le radiateur et votre corps.

CAN ICES-3 (B)/NMB-3(B)

Simplified EU Declaration of Conformity

Hereby, Schneider Electric declares that the radio equipment type 865-0329 is in compliance with Directive 2014/53/EU. The full text of the EU declaration of conformity is available at the following internet address:

<https://solar.schneider-electric.com/>

Schneider Electric Products that Work with the InsightFacility

- Conext XWPro Inverter / Charger:
 - Conext XW Pro 8548 Product No. 865-8548-55
 - Conext XWPro 6848 NA Product No. 865-6848-21
- Conext XW+ Inverter / Chargers:
 - Conext XW+ 7048 E Product No. 865-7048-61
 - Conext XW+ 8548 E Product No. 865-8548-61
 - Conext XW+ 5548 NA Product No. 865-5548-01
 - Conext XW+ 6848 NA Product No. 865-6848-01
- Conext SW Inverter / Chargers:
 - SW 2524 120/240 Product No. 865-2524
 - SW 4024 120/240 Product No. 865-4024
 - SW 2524 230/240 Product No. 865-2524-61
 - SW 4024 230/240 Product No. 865-4024-61
- Conext MPPT 60 150 Solar Charge Controller: Product No. 865-1030-1
- Conext MPPT 80 600 Solar Charge Controller: Product No. 865-1032
- Conext System Control Panel (SCP): Product No. 865-1050-01
- Conext Automatic Generator Start (AGS): Product No. 865-1060-01
- Conext Battery Monitor: Product No. 865-1080-01

Dimensions

NOTE: Specifications subject to change without prior notice.

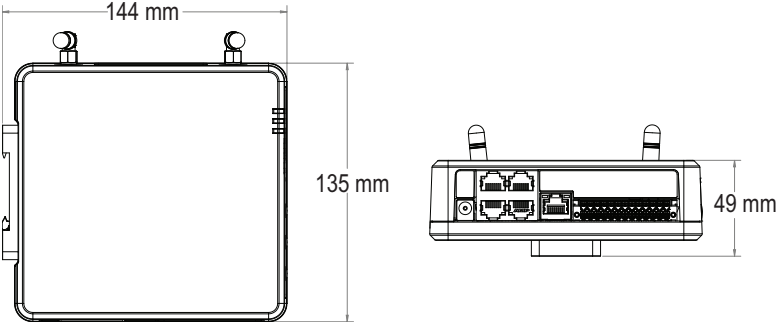

A Installing the InsightFacility Security Certificate

What's in This Chapter?

Root Certificates	79
-------------------------	----

Root Certificates

InsightFacility does not support 3rd party root certificates as it is a server on your local area network with a potentially dynamic IP address and no public server name. As a result, web browsers will pop up a warning message similar to the one shown below¹:

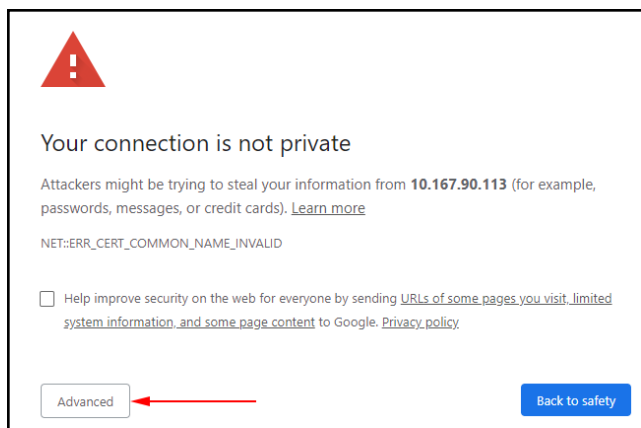

In order to connect to the InsightFacility local web page you must confirm the warning and tell the browser that it is ok to connect to the gateway. The exact procedure for this will be slightly different depending on the browser version you are using.

In this example¹, follow these steps:

1. Click the **Advanced** button in the bottom left of the window to view more data.
2. Click **Proceed to <IP address>** in the bottom left of the window to navigate to the InsightFacility web page.

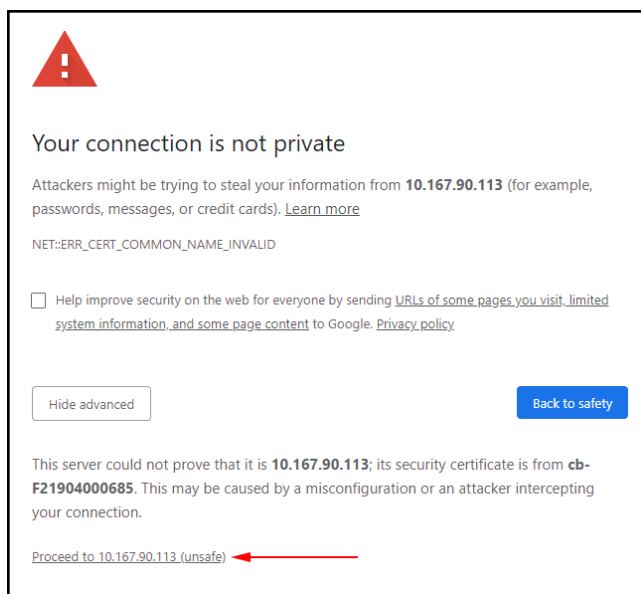

¹ Examples shown are applicable to Chrome Version 86.0.4240.111 (Official Build) (64-bit)

Schneider Electric

As standards, specifications, and designs change from time to time, please ask for confirmation of the information given in this publication.

For other country details please contact your local Schneider Electric Sales Representative or visit the Schneider Electric Solar Business website at: <http://solar.schneider-electric.com/>

© 2020 Schneider Electric. All Rights Reserved.